

# ***MultiView™ II*** ***DVI-Tx*** Transmitter



## **Installation and User Guide**

Version 1.20



2791 Circleport Drive, Erlanger, KY 41018, USA.  
Americas: 859-282-7303  
EMEA: +44 (0) 1843 873322  
Email: [tech.usa@tvone.com](mailto:tech.usa@tvone.com)  
[www.tvone.com](http://www.tvone.com)

## **Manual Copyright Notice**

This document and the Magenta Research products to which it relates, and the copyright in each, is the intellectual property of tvONE, ©2014. Neither the document nor the products may be reproduced by any means, in whole or in part, without the express prior written permission of tvONE.

## **Disclaimer**

tvONE makes no warranty or representation, either express or implied, with respect to this software or documentation, including their quality, performance, merchantability, or fitness for a particular purpose. As a result, this software or documentation are licensed "as is" and you, the licensee, are assuming the entire risk as to their quality and performance.

In no event will tvONE be liable for direct, indirect, special, incidental, or consequential damages arising out of the use of or inability to use the software or documentation.

Magenta Research and the Magenta Research logo are trademarks owned entirely by tvONE. All other brands, product names, and trademarks are the property of their respective owners.

## Regulatory Compliance Statements

### FEDERAL COMMUNICATIONS COMMISSION AND INDUSTRY CANADA RADIO FREQUENCY INTERFERENCE STATEMENTS

This device complies with part 15 of the FCC Rules. Operation is subject to the following two conditions:

1. This device may not cause harmful interference, and
2. This device must accept any interference received, including interference that may cause undesired operation.

This equipment has been tested and found to comply with the limits for a Class A digital device, pursuant to part 15 of the FCC Rules. These limits are designed to provide reasonable protection against harmful interference when the equipment is operated in a commercial environment. This equipment generates, uses, and can radiate radio frequency energy and, if not installed and used in accordance with the instruction manual, may cause harmful interference to radio communications. Operation of this equipment in a residential area is likely to cause harmful interference in which case the user will be required to correct the interference at his own expense.

Canada (ICES-003) notice:

This Class A digital apparatus complies with Canadian ICES-003.  
Cet appareil numérique de la classe A est conforme à la norme NMB-003 du Canada.

### EUROPEAN UNION DECLARATION OF CONFORMITY

Warning: This is a Class A product. In a domestic environment this product may cause radio interference in which case the user may be required to take adequate measures.

TV One (Erlanger KY USA) declares under our sole responsibility that the product *MultiView™*  
// DVI-Tx to which this declaration relates is in conformity with the following standard(s) or other normative documents:

EN 55032:2012 Class A ITE emissions requirements.  
EN61000-3-2:2006 Limits for harmonic current emissions (equipment input current up to and including 16A per phase).  
EN 61000-3-3:2013 Limitation of voltage fluctuations and flicker on low-voltage supply systems for equipment with rated current up to and including 16A.  
EN60950-1:2006 Safety for Information Technology Equipment  
EN55103-2 Immunity for ITE:  
BS EN61000-4-2 All Environments E1-E5 Electrostatic discharge  
BS EN61000-4-3 All Environments E1-E4 NOT Environment E5 Radiated RF Immunity  
BS EN61000-4-4 All Environments E1-E4 NOT Environment E5 Fast transient Immunity (EFT)  
BS EN61000-4-5 All Environments E1-E4 NOT Environment E5 Surges  
BS EN61000-4-6 Environments E1-E4 NOT Environment E5 Conducted RF Immunity  
BS EN61000-4-11 All Environments E1-E5 Voltage Dips and Interruptions

**WARNING:** An AC adapter with a ferrite core must be used for RF interference suppression.

To assure continued FCC Class A emission limit compliance, the user must only use shielded video cables with two ferrite cores to avoid potential harmful interference when connecting to external units and F/UTP<sup>‡</sup> type Category cable must be used.

This equipment has more than one interface connector, do not leave cables connected to unused interfaces. Any unauthorized changes or modifications to this equipment could void the user's authority to operate it.

Direct all inquiries regarding FCC compliance to:  
tvONE 2791 Circleport Drive, Erlanger, KY 41018, USA  
Phone: 859-282-7303 Fax: 859-282-8225 Email: tech.usa@tvone.com

<sup>‡</sup> F/UTP cable is constructed of 4 unshielded twisted pairs, with a foil screen around all 4 pairs

# Precautions

## Safety Instructions • English



This symbol calls attention to important information.



This symbol alerts the user of important maintenance (or servicing) and operating information.



This symbol alerts the user to the presence of un-insulated dangerous voltages or other conditions in, or around, the product enclosure. These conditions can present a risk of electric shock or damage to equipment or facilities.

**Connection** • Not for direct connection to Telecommunication Network Circuitry (TNV)

**Power sources** • This equipment should be operated only from the power source indicated on the product. Disconnect all power sources before servicing.

**Power disconnection** • To remove power from the equipment safely, remove all power cords from the rear of the equipment, or from the power source receptacle (wall plug).

**Power cord protection** • Power cords should be routed so that they are not likely to be stepped on or pinched by items placed upon or against them.

**Servicing** • Refer all servicing to qualified service personnel.

**Slots and openings** • If the equipment has slots or holes in the enclosure, these are provided to prevent overheating of sensitive components inside. These openings must never be blocked by other objects.

## Caution:

**Read Instructions:** Read and understand all operating, installation, and safety instructions before using this equipment.

**Avoid Attachments:** Only use accessories, attachments, tools, and materials that are recommended by the equipment manufacturer. Doing otherwise can compromise operating performance, create an unsafe condition, damage equipment, or violate the terms of usage or warranty.

**Follow Warnings:** Always follow all instructions and warnings marked on the equipment or as detailed in related users' guides.

# Table of Contents

	<b>Page</b>
Chapter 1	Specifications ..... 1
	1.1 DVI Interface ..... 1
	1.2 DDC/EDID Support ..... 2
	1.3 Auxiliary Signal Support ..... 2
	1.3.1 Auxiliary Signal support: (A/S) versions ..... 2
	1.3.2 Auxiliary Signal support: SAP version ..... 3
Chapter 2	About this Manual ..... 4
Chapter 3	Product Overview ..... 5
	3.1 Front Panel Interfaces ..... 5
	3.2 Rear Panel Interfaces ..... 6
Chapter 4	Twisted-pair Cable Compatibility ..... 7
Chapter 5	Installation ..... 8
	5.1 Option-Module Configuration ..... 8
	5.2 Prerequisites ..... 8
	5.3 Installation Procedure ..... 8
	5.4 Adjustments ..... 11
	5.5 Cable Distance (EQ) Compensation Settings ..... 11
	5.6 Skew Compensation Settings ..... 12
	5.7 Configuration ..... 12
	5.7.1 Sync Settings ..... 14
	5.7.2 4 <sup>th</sup> Pair Settings ..... 15
Chapter 6	Troubleshooting ..... 16
Chapter 7	Connector Pinouts ..... 17
Appendix A	Supported Video Formats and Features ..... 22
Appendix B	(SAP) Option Module Settings ..... 23
Appendix C	Pollable Serial Mode Address Chart ..... 24
Appendix D	Mounting Kits ..... 26
Appendix E	Magenta Equipment Compatibility ..... 28

## Chapter 1 Specifications

The following table lists the general specifications of the MVII-DVI-Tx.

**Table 1: MVII-DVI-Tx General Specifications**

Item	Description
Link Cable Required	4 twisted-pair "F/UTP <sup>‡</sup> " type cable is recommended for performance and EMC compliance. Regular or minimized-skew type is acceptable.
Supported Video Formats	VESA and CEA video formats, input on a digital DVI-D connector. Supported video formats include 1080p/60/24. Refer to Appendix-A for a full list of supported resolutions.
Audio Signals	<b>(A) Mode:</b> Supports L+R summed audio input, 47K ohms input impedance. A source device with 600 ohms maximum output impedance is recommended. <b>(S/PDIF mode):</b> For S/PDIF digital-audio, 75 Ohm (typical input impedance). Note: The DVI-Tx (transmitter) can also de-embed 2CH-PCM digital audio, which can be extracted as a S/PDIF digital audio stream at the receiver.
Serial Characteristics	<b>(S) mode:</b> Protocol: Asynchronous; transparent to data format; transparent to data rates up to 115 kbps; simplex. <b>(SAP) model:</b> Protocol: Asynchronous; 9 fixed baud rates are supported, refer to SAP-II Programming Manual for additional details
Connectors	(2) DVI-D (F) (Video in/out) (1) 4 pin phoenix (Auxiliary signal input) (1) RJ-45 (F/UTP link output) (1) DB9F (only if the SAP option module is installed) (1) DC power jack
Temperature/Humidity Tolerance	Operating: 32 to 104°F (0 to 40°C), 10% to 80% RH non-condensing. Storage: -4 to +140°F (-20 to +60°C), 10% to 80% RH non-condensing.
Enclosure	Steel, black powder-coat finish.
Power	Input voltage: +5 VDC @ 1.2 Amps max. Consumption: 6 watts maximum
Size	1.2"H x 4.2"W x 4.3"D (3.0 x 10.4 x 10.9 cm)
Weight	1 lb. (0.45 kg)

### 1.1 DVI Interface

The DVI interfaces (video-in and local video-out) have the following characteristics:

Item	Description
Video Support	VESA and CEA video formats, input on a digital DVI-D connector. Supported video formats include 1080p/60/24. Refer to Appendix-A for a full list of supported resolutions.  Video output formats (local output port): The local port is essentially a direct copy of the video input port.
Video Connectors	(1) DVI-D input connector, (1) DVI-D output connector.
Audio Characteristics	There is a 4 <sup>th</sup> -pair configuration setting which allow de-embedding of 2CH-PCM digital audio. The digital audio is sent on the 4 <sup>th</sup> -pair as a SPDIF digital audio stream.
EDID/DDC	This module supports the EDID/DDC connections on the DVI-D input connector.
HDMI	It is usually possible to connect to HDMI devices (via a plug-adaptor or cable-adaptor). Embedded HDMI stereo audio is supported.
CEC	Not supported, even if a "HDMI-to-DVI" plug-adaptor or cable-adaptor is used.

<sup>‡</sup> F/UTP cable is constructed of 4 unshielded twisted pairs, with a foil screen around all 4 pairs

## 1.2 DDC/EDID Support

For best compatibility with source devices (eg, a PC), an extension device (DVI-Tx in this case) should provide an appropriate DDC/EDID profile with the proper resolution and timing information to that source device. This helps ensure best compatibility with display devices connected at the remote end.

The DVI-Tx is factory-programmed with a fixed EDID table. The supported video formats are detailed in Appendix-A.

Unlike many other MultiView transmitter devices, it is not possible to “copy EDID data” from a display into the DVI-Tx. This is not necessary because all the compatible digital video formats supported by the DVI-Tx are already present in the factory-supplied EDID table.

## 1.3 Auxiliary Signal Support

The DVI-Tx is available in 2 factory-configured models, which allow different types of signals to be passed over the 4<sup>th</sup>-pair on the CAT5 cable. These are configured differently by a front-panel setting, or may include an internal hardware option-module.

- **MVII-DVI-Tx-A/S:**
  - (-A) mode: Supports L+R summed audio (user-configuration setting).
  - (-S) mode: Supports 2-wire RS-232 serial in simplex mode (user-configuration setting).
  - SPDIF mode: Supports S/PDIF pass-through on the 4<sup>th</sup>-pair.
  - HDMI/DVI de-embedding mode: Extracts 2CH-PCM digital audio and sends out a SPDIF stream on the 4<sup>th</sup> pair.
- **MVII-DVI-Tx-SAP:**
  - Supports 3-wire RS-232 serial (simplex or duplex), and true stereo audio.
  - The serial feature is POLLABLE, so that multiple receivers on a daisy-chained link can be addressed individually for display control or status-query.
  - Contains the (SAP) option module.

The SAP option module is a factory-installed option. However, a field upgrade to the SAP version is possible. It will require some minor technical skill to install the module. **Please contact tech support for information and assistance for these upgrades.**

Note that for each DVI-Tx version above, the accompanying receiver device (DVI-Rx-1K, but also AK600/AK1200DP receivers) must be similarly configured with regards to the 4<sup>th</sup>-pair settings. For more specific information on MultiView™ receivers, please refer to the user-guide provided with your desired receiver.

### 1.3.1 Auxiliary Signal support: (A/S) versions

The DVI-Tx models without any option module installed are capable of one of these auxiliary functions at a time, selected by a user-configuration setting:

- **(A) mode:** Analog L+R summed audio.
- **(S) mode:** Simplex RS-232 support.
  - Provides simplex (TX-only) serial data, even with daisy-chained receivers.
  - Data is transmitted to all attached receivers. No data can ever be received.
  - Receivers are not individually addressable.
  - The RS-232 interface supports a 2-wire interface: TX/GND.
  - Baud rates up to 115.2K is supported. No settings required.
  - Transparent to format and protocol.
- **SPDIF mode:** Allows S/PDIF digital audio to pass through on the 4<sup>th</sup>-pair.
- **De-embedded audio mode:** The 2CH-PCM digital audio content from a HDMI/DVI video interface can be extracted as a SPDIF digital audio stream, and sent to the 4<sup>th</sup>-pair signal pair.

### 1.3.2 Auxiliary Signal support: SAP version

The MVII DVI-Tx-SAP comes equipped with an internal hardware SAP option module, enabling full-duplex RS-232 serial (no hardware handshaking signals) and stereo audio. The SAP module in the DVI-Tx has no address-switch settings. However, it is important to check the address-switch settings in the connected Receiver SAP units (DVI-Rx-1K-SAP, AK600/1200DP-SAP etc.). Please refer to Appendices B and C for information on setting the address-switches on the Receiver SAP modules.

- Simplex or Duplex RS-232 support.
  - Provides simplex or duplex serial data, even with daisy-chained receivers.
  - Data is transmitted and received using “broadcast” mode by default.
  - If desired, receivers are individually addressable.
  - RS-232 interface supports a 3-wire interface: TX/RX/GND.
  - Baud rate is adjustable in 9 steps from 1200 to 115K BAUD.
    - The factory-default speed is 9600 BAUD.
  - **Note:** The Receiver SAP modules must have their SAP address configured correctly.
    - The factory-default setting for all (SAP) modules is address-0. This is the “broadcast” address.
    - **Note:** All Receiver SAP address configuration changes (via DIP switches, see **Appendix C**) should be done before making any cable connections and applying power.
- Audio: L/R true stereo audio is supported simultaneously with serial data.
  - Audio gain/mute settings are under serial control.
- The SAP module provides many additional user-configurable settings, available through the serial port.  
**Please refer to the SAP-II Programmer’s Guide for additional details.**

Note that in cases where a DVI-Tx-SAP transmitter is routed through a DA (Distribution Amp, such as a MultiView 9D for example), or a Mondo (or other) video switch, the SAP module will provide simplex serial (TX-only, though the addressable-receiver and stereo-audio features still work). In this mode, receive-direction serial data (RX) is ignored.



## Chapter 2 About this Manual

This manual describes the Magenta MultiView™ II DVI-Tx transmitter, and contains the following information:

- Specifications (Chapter 1)
- Product Overview (Chapter 3)
- Twisted-pair Cable Compatibility (Chapter 4)
- Installation (Chapter 5)
- Troubleshooting (Chapter 6)
- Connector pinouts (Chapter 7)
- Additional information (Appendices)

The Magenta MultiView™ II family (MVII) of products introduces greater compatibility for handling HD video standards, as well as making nearly all user-configurable options “jumperless” via a digital front-panel user-interface.

### Compatibility with MultiView receivers:

- The MultiView-II DVI-Tx transmitter is primarily intended for use with the MultiView-II DVI-Rx-1K Receiver.
- It can also be used with standard (legacy) MultiView and (new) MultiView-II receivers.
  - In these applications, the DVI-Tx transmitter enables a digital video source to effectively drive an analog (VGA) display at the receiver.
  - There may be video-format and timing limitations, which may result in some digital formats not displaying correctly on typical analog VGA displays.
  - It is essential that the desired configuration be tested with the actual sources & displays needed for the specific application.
- The DVI-Tx supports all legacy MultiView sync-modes, including RepliSync-I and RepliSync-II.



### The MultiView-II DVI-Rx-1K ONLY operates in Fixed Sync mode (default)

**Compatibility with MultiView switching and distribution:** The MultiView-II DVI-Tx transmitter is generally compatible with previous MultiView distribution and switching products. Contact Technical Support for specific system configuration and compatibility issues.

The following table shows the factory-configured versions of the MVII-DVI-Tx.

**Table 2: Available MVII-DVI-Tx Versions**

Version	Description
MVII-DVI-Tx- <b>A/S</b>	Supports L+R summed audio (user-configuration setting). Supports simplex serial (user-configuration setting).
MVII-DVI-Tx- <b>SAP</b>	Supports 3-wire RS-232 serial (simplex or duplex), and true stereo audio. The serial feature is POLLABLE, so that multiple receivers on a daisy-chained link can be addressed individually for display control or status-query. <b>Contains the (SAP) hardware option module.</b>

### Note:

1. The –A/S version is also field-configurable for S/PDIF digital audio extension on the 4<sup>th</sup>-pair.



**This equipment is not intended for, nor does it support, distribution through an Ethernet network. Do not connect these devices to any sort of networking or telecommunications equipment.**



**Use only approved MultiView™ power adapters. Failure to do so may damage this device and will void the warranty.**

## Chapter 3 Product Overview

The MVII-DVI-Tx is a video transmitter that is compatible with the MVII-DVI-Rx-1K receiver, and many legacy MultiView products – contact Technical Support with compatibility questions. It extends a digital video signal over standard twisted-pair “F/UTP” type cable. There are user-configurable settings for video, audio, and serial options which can be controlled from the front panel.

The MVII-DVI-Tx supports a wide range of video refresh rates and resolutions (refer to Appendix-A).

### 3.1 Front Panel Interfaces

The front panel of the MVII-DVI-Tx has the following controls and indicators:

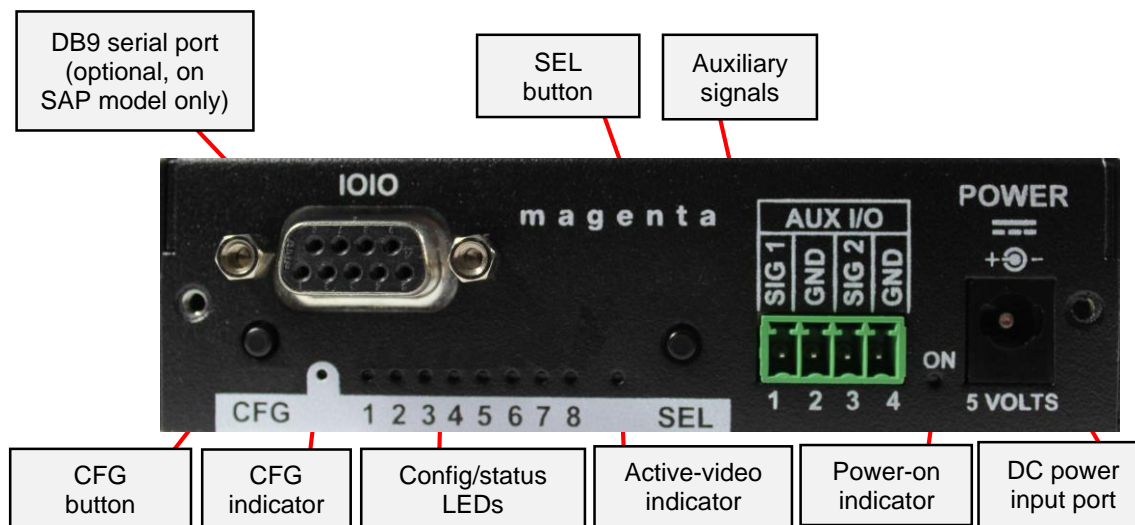

**Figure 1: MVII-DVI-Tx Front Panel Interfaces**

There are two buttons (**CFG** and **SEL**) and several LED status indicators. All are used to display and control the operating modes of the transmitter. The **CFG** indicator shows these modes:

- In normal mode, the **CFG** indicator is off.
- In configuration mode, the **CFG** indicator will be on.

### 3.2 Rear Panel Interfaces

The rear panel of the MVII-DVI-Tx has the following ports:

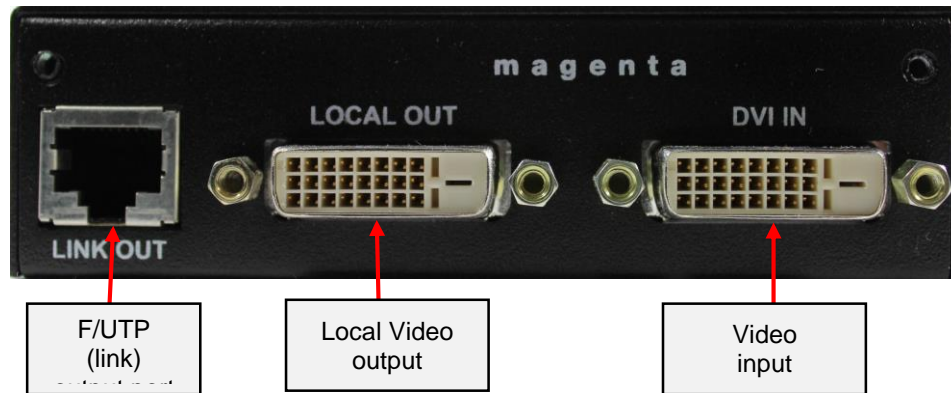

**Figure 2: MVII-DVI-Tx Rear Panel Interfaces**

## Chapter 4 Twisted-pair Cable Compatibility

The MVII-DVI-Tx transmitter is compatible with twisted-pair “F/UTP” type cable. This type of cable ensures best possible product performance, and maintains EMC compliance for emissions and susceptibility. However, in applications that must use cable other than “F/UTP”, it is up to the end-user to ensure product performance at the intended resolution and distance, and that additional steps are taken to mitigate any RF interference.

In the F/UTP cable category, there is regular-skew (or IT-grade) cable, and in some areas, “minimized skew” (video-grade) cable may be available. The DVI-Tx transmitter is compatible with both types. Follow these tips to ensure proper usage of your Category cabling:

- Some “low-skew” cable is specific to a particular vendor and is incompatible with our products. Ensure that any “low-skew” cable is non-proprietary before purchase and installation.
- CAT6 cable, due to the manufacture method, can exhibit much greater skew than standard CAT5/5e. Please contact tech-support for assistance.
- Cabling for the Magenta MultiView™ Series must be pinned to the TIA-EIA T568B wiring specification.
- We also highly recommend that all cables be pre-terminated and tested. Cables terminated on-site or in an existing infrastructure should be tested before use to ensure compliance with the TIA-EIA T568B specification. Using incorrectly terminated cables can damage the Magenta MultiView™ Series.
- The cable should be suitably rated Listed cable ( DUZX ) communication cables, TYPE CMP, CMR, CMG or CM as designated in the NEC.
- Cables are to be installed in accordance with the NEC and local building and electrical codes. This is the responsibility of the end user/installer of this product.

The following figure shows the T568B Wiring specification.

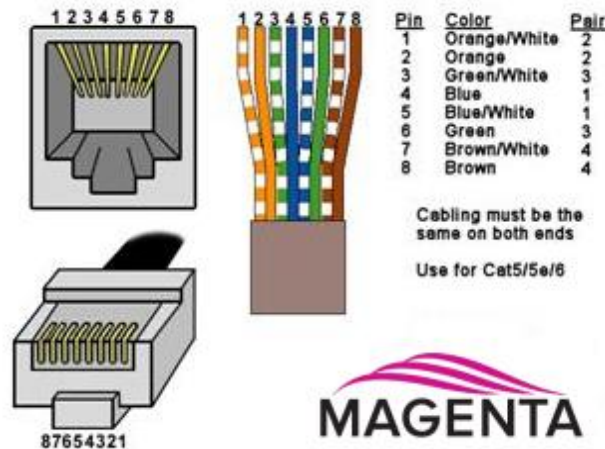

**Figure 3: T568B pinout for RJ45 connectors and twisted-pair cables**

## Chapter 5 Installation

This section describes the following installation topics:

- Data mode configuration
- Prerequisites to installation
- Installation procedure
- Post-installation adjustments
- Post-installation configuration settings



**This equipment is not intended for, nor does it support, distribution through an Ethernet network. Do not connect these devices to any sort of networking or telecommunications equipment!**



**Do not connect DC power until instructed to do so.**

### 5.1 Option-Module Configuration

If your MVII-DVI-Tx transmitter is equipped with the (SAP) option, then the following information will be important to review BEFORE installing the –SAP equipped receiver:

The companion **-SAP** equipped receiver (MVII-DVI-Rx-1K, or legacy –SAP type receivers) offers pollable RS232 duplex serial in addition to stereo audio. The serial interface is 3-wire (TX, RX, GND) and does not support full modem signals. The factory-default serial baud rate is 9600 baud, but this is a user-configurable option using “SAP-II” serial commands. Simplex modes are supported without jumper or other changes by simply using the TX signal only. The SAP-module capability of polling and interacting with specific receivers requires that each receiver have a unique address setting. Please refer to Appendix-B for (SAP) module configuration information, and Appendix-C for SAP-address settings.

### 5.2 Prerequisites

Depending on the specific installation requirements, some common tools (screwdrivers, nut-drivers) and related hardware (mounting screws) might be required. These are not provided with Magenta products.

The following items might be necessary, which are available from Magenta Research:

- Audio cable: Phoenix 4-pin to RCA.
- Video cable(s): DVI (or HDMI with an appropriate DVI/HDMI adapter)
- Serial cable: Phoenix 4-pin to DB9, or one of several DB9-M/F, M/M or F/F extension cables.

**Note:** You will need appropriate twisted-pair cable as previously described, to connect the MVII-DVI-Tx to other MultiView™ devices. tvONE does not supply this cable.

### 5.3 Installation Procedure



**Ensure that all connectors are clean and free of contaminants prior to making the connections. Appropriate connector locking hardware (screws/latches) should be used to prevent cables from disconnecting or causing intermittent operation.**



**All units must be the same type for 4<sup>th</sup>-pair supported features to function correctly. For example, a “MVII-DVI-Tx-A” must be paired with a MVII-DVI-Rx-1K-A, as both must be identical to work properly. Similarly, an “MVII-DVI-Tx-SAP” can only be used with an MVII-DVI-Rx-1K-SAP”. Video modes may function normally, but 4th pair options will not.**

**To install a MultiView-II DVI-Tx transmitter:**

1. Connect the source video to the Magenta MultiView™ DVI-Tx transmitter's video input port, which is a DVI-D connector labeled DVI-IN.
2. If desired, attach a local monitor to the DVI-D connector labeled LOCAL OUT (if available).
3. Make your audio or serial connections via the AUX-I/O (Phoenix) connector or DB9 connector as appropriate.
4. Connect the twisted-pair cable to the transmitter.
5. Apply power to the transmitter.
  - a. The power-on LED should light up.
  - b. If there is a local monitor attached, a video image should appear on the monitor.

### To install the MVII-DVI-Rx-1K receiver:

1. Connect the DVI OUT connector to the display.
2. Connect any audio and/or serial cables to the (AUX I/O) and (IOIO) connectors, depending on the specific model of receiver you are installing. Please refer to the –A, -S or –SAP option descriptions for more information.
3. Connect the twisted-pair cable from a MultiView-II™ DVI-Tx transmitter to the LINK INPUT connector on the receiver.
4. If you are daisy-chaining multiple receivers, also connect the downstream twisted-pair cable to the LINK OUTPUT port on the receiver.
5. Connect the DC power cable to the POWER port, and check for the following indicators:
  - The power-on LED should light up (Green).
  - The CFG indicator is off.
  - The SKEW/RGB indicator is off.
  - The EQ/SKEW indicators display the current EQ settings (0 to 100%).
6. **IMPORTANT:** The MVII-DVI-Rx-1K will auto-adjust the EQ and Skew settings. This is the factory-default behavior. However, in some applications it will be necessary to manually fine-tune these adjustments, or leave it in manual-adjust mode after the initial setup.
7. When the EQ and SKEW settings are properly adjusted, the video should appear on the display (make sure display is powered ON).
8. Make any other required configuration changes via the LED/button user-interface.



**It is critical that the EQ and SKEW settings be adjusted to compensate for the length of the twisted-pair cable leading back to the transmitter.**

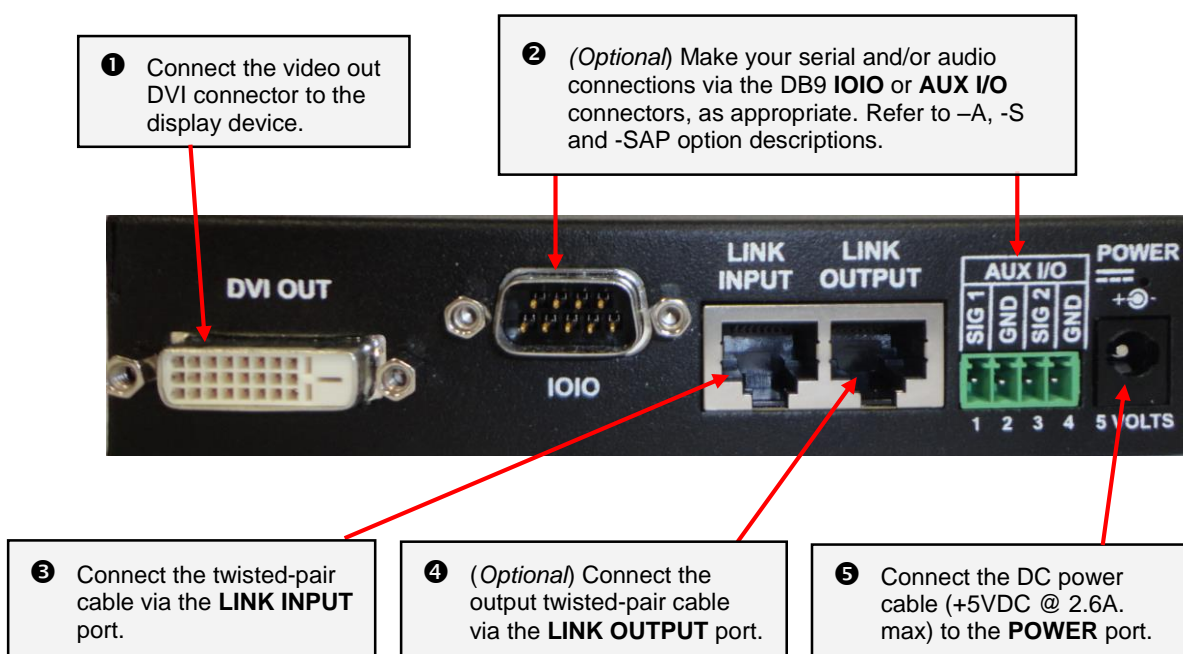

**Figure 4: MVII-DVI-Rx-1K Receiver connections**

## 5.4 Adjustments

This section describes how to make the following adjustments:

- Cable distance (EQ) compensation
- Skew compensation

Note that the factory-default behavior of the MVII-DVI-Rx-1K “auto-adjust mode enabled” for the EQ and skew-comp. To **exit auto-adjust mode**, simply attempt to make a manual adjustment to either EQ or Skew.



To **re-enable auto-adjust mode**, simply push both UP and DOWN buttons simultaneously when the receiver is operating in “normal mode”.

## 5.5 Cable Distance (EQ) Compensation Settings

When the MVII-DVI-Rx-1K is operating in normal mode (CFG indicator is off), it is possible to quickly adjust the EQ. The EQ/SKEW indicators 1-8 will change accordingly to show (in “bar-graph” form) 0 to 100% of the available EQ adjustment range.



For best results, use the **Magenta EQ/Skew test pattern image if possible**. A test pattern image and video instructions is available at <http://www.magenta-research.com/test>.

The following figure shows the test image you can use to make the EQ adjustment.

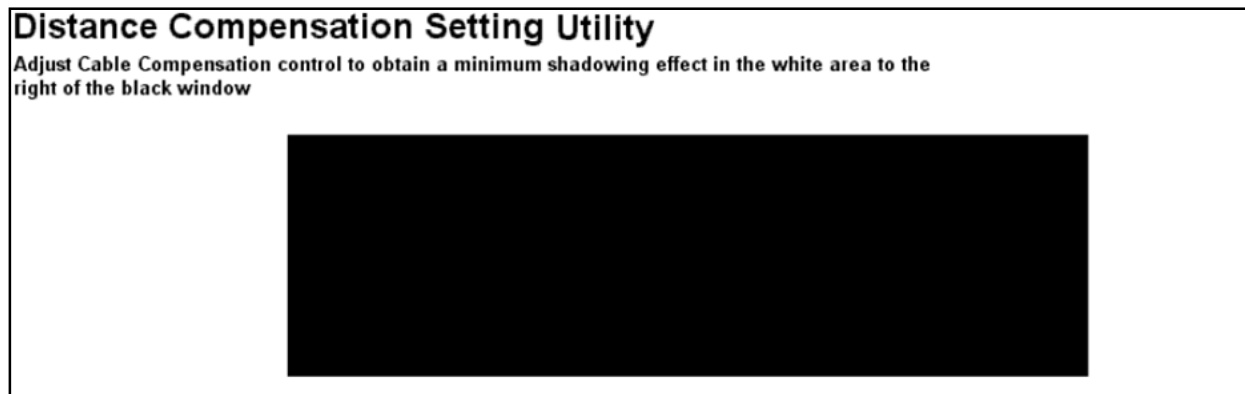

*Figure 5: EQ-adjustment test image*

### To adjust EQ:

1. From normal-mode, press and hold the UP or DOWN button until the SKEW/RGB indicator turns on (VIOLET). Release the UP or DOWN button.
2. Press the UP or DOWN buttons repeatedly to adjust the EQ setting, either one step at a time or hold for auto-repeat.
3. To exit EQ-ADJUST mode, leave the buttons untouched for 10 seconds, or press the CFG button once.



## 5.6 Skew Compensation Settings

The AkuComp-II skew module is already included inside the standard MVII-DVI-Rx-1K receiver. It is possible to quickly adjust the RGB skew-compensation values when the receiver is operating in normal mode. The EQ/SKEW indicators 1-8 will change accordingly to show (in “bar-graph” form) 0 to 100% of the available SKEW adjustment range (0 to 65nSec).



**For best results, use the Magenta EQ/Skew test pattern image if possible. A test pattern image and video instructions is available at <http://www.magenta-research.com/test>.**

The following figure shows the test image you can use to make the SKEW adjustment.

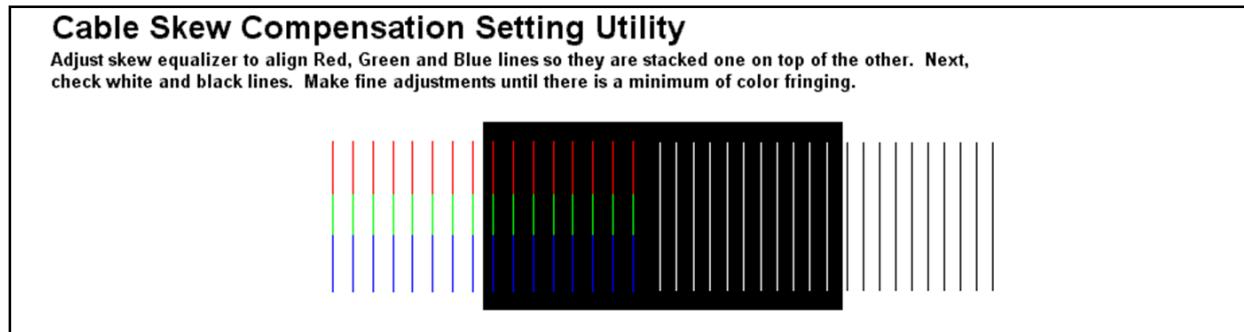

Figure 6: Image Adjustment Utility Skew

### To adjust skew:

1. From normal mode, press and hold the SKEW/SEL button until the SKEW/RGB indicator turns on RED. Release the SKEW button.
2. Press the UP or DOWN button repeatedly to adjust the RED skew value.
3. Press and release the SKEW/SEL button. The SKEW/RGB indicator will turn GREEN.
4. Press the UP or DOWN button repeatedly to adjust the GREEN value.
5. Press and release the SKEW/SEL button. The SKEW/RGB indicator will turn BLUE.
6. Press the UP or DOWN button to adjust the BLUE value.
7. Pressing the SKEW/SEL button again will return you to step-2, allowing adjustment of the RED skew again.
8. To exit SKEW-ADJUST mode, leave the buttons untouched for 10 seconds or press the CFG button.

## 5.7 Configuration

The DVI-Tx has a number of configurable operating parameters, and the factory-default settings will work in most applications. However, some applications may require configuration changes. Nearly all settings are available from the front-panel buttons/LEDs. The enclosure does not need to be opened **unless** the SAP option module is being installed or removed.

For all configuration settings, the DVI-TX must be in CONFIG mode (CFG indicator is on). Once in CONFIG mode, any changes are effective immediately and are saved in non-volatile memory.

- **To enter configuration-mode:** Press **CFG** button once. The **CFG indicator** will turn on, confirming you are in configuration-mode. Once in this mode, the LED indicators 1-8 will display the current settings as described in the tables below.
- **To exit configuration-mode:** Leave the buttons untouched for 10 seconds. The **CFG indicator** will turn off (normal-mode).

**To quickly reset all user-configurable options back to factory-default settings:**

1. Disconnect the DC power cable (or AC power).
2. Press and hold the **CFG** button.
3. Connect the DC power cable (or AC power). All LEDs blink 3 times, indicating all settings are now changed back to factory-defaults.
4. Release the **CFG** button.

## 5.7.1 Sync Settings

The DVI-Tx supports the complete set of MultiView sync modes:

- RepliSync-I, RespliSync-Ia (normal/stretched): Generally needed for legacy MultiView receivers.
- RepliSync-II: Required for newer MultiView-II receivers.
- Auto-detect RSI/RSIa: The DVI-Tx will automatically select RepliSync-I or RepliSync-II, depending on video format.
- Fixed-Sync: Necessary for some legacy receivers and VGA displays.







**Note that Fixed-sync is the factory-default setting, and is required when connecting to the companion MVII-DVI-Rx-1K receiver.**

Note that any connected MultiView™ receiver should generally be set to the same sync-mode and may require other configuration adjustments (such as sync-polarity when using fixed-sync). Otherwise, you may not get a proper video display output at that receiver, or none at all.

Perform the procedure below while the transmitter is in the normal operating state (**CFG** indicator is off):

- Press and release the **CFG** button once to access configuration-mode (**CFG indicator = on**).
- Press and release the **SEL** button **once**. You will now be able to change sync-mode settings.
- LED indicators 1-3 should be illuminated (either DIM or ON); all others (indicators 4-8) should be off.
- Press the **CFG** button repeatedly to step through the available sync-mode settings as shown below.
- To leave configuration-mode step through all the options OR leave the buttons untouched for 10 seconds.

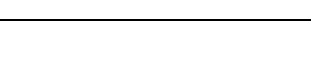
LED1	LED2	LED3	Front Panel View	Sync-mode Setting
dim	dim	dim		The DVI-Tx will auto-detect the required RepliSync-I mode (“normal” or “stretched”).
dim	dim	ON		Force RepliSync-I normal Horizontal sync. pulse encoding.
dim	ON	dim		Force RepliSync-I “stretched” Horizontal sync. pulse encoding.
dim	ON	ON		Force RepliSync-II (only compatible with MVII type analog receivers).
<b><u>ON</u></b>	<b><u>dim</u></b>	<b><u>dim</u></b>		Force fixed-sync mode. <b>NOTE:</b> All connected MultiView receivers must also be in fixed-sync mode and with the appropriate H/V polarities selected. <b>This is the <u>factory-default</u> setting, and this is the <u>required</u> mode when interfacing to a MultiView-II DVI-Rx-1K receiver.</b>

## 5.7.2 4<sup>th</sup> Pair Settings







The DVI-Tx provides several options for using the 4<sup>th</sup>-pair signals (pairs 1-3 are generally used for video). Note that any connected MultiView™ receiver must be configured with a matching 4<sup>th</sup>-pair operating mode. Otherwise, the desired 4<sup>th</sup>-pair signal will not work as expected.



**If the optional SAP daughterboard is installed, then the 4<sup>th</sup>-pair utilization is defined by the installed daughterboard. It will not be possible to change any of the 4<sup>th</sup>-pair settings as described below.**

Perform the procedure below while the transmitter is in the normal operating state (**CFG indicator is off**):

- Press and release the **CFG** button once to access configuration-mode (**CFG indicator = on**).
- Press and release the **SEL** button **twice**. You will now be able to change 4<sup>th</sup>-pair option settings.
- LED indicators 4-6 should be illuminated (either DIM or ON); all others (indicators 1-3, 7 and 8) should be off.
- Press the **CFG** button repeatedly to step through the available 4<sup>th</sup>-pair settings as shown below.
- To leave configuration-mode step through all the options OR leave the buttons untouched for 10 seconds.

LED4	LED5	LED6	Front Panel View	4 <sup>th</sup> -pair Operating Mode <i>Note: if the SAP daughterboard is installed these cannot be changed.</i>
dim	dim	dim		<b>If SAP option-module is installed:</b> 4 <sup>th</sup> -pair operating mode is fixed to SAP mode and this setting cannot be changed <b>If the SAP option-module is not installed:</b> 4 <sup>th</sup> -pair signals are disabled. This effectively “mutes” anything being sent on the 4 <sup>th</sup> pair. This can be useful for diagnostic purposes.
dim	dim	ON		Direct pass-through of 4 <sup>th</sup> -pair wires (custom applications).
<u>dim</u>	<u>ON</u>	<u>dim</u>		<b>External analog (L+R summed) audio. This is the factory-default mode if no daughterboard option is installed. (-A mode).</b>
dim	ON	ON		External S/PDIF digital audio. Input-impedance = 75-ohms.
ON	dim	dim		Simplex-serial (“-S” mode).
ON	dim	ON		Internal S/PDIF digital audio, de-embedded from the video stream. The S/PDIF stream is transmitted on the 4 <sup>th</sup> -pair.

## Chapter 6 Troubleshooting

In most cases, nearly every issue with the MultiView™ video system can be resolved by checking the twisted-pair cable termination and making sure that it's pinned to the TIA/EIA 568B wiring specification. However, there may be other problems that cause the system to not perform as it's designed. The following table lists the most common installation errors and their solutions.

**Table 3: Troubleshooting Problems and Solutions**

Problem	Solution
No video signal at the receiver	<ul style="list-style-type: none"> <li>• Check that the transmitter is a MultiView-II DVI-Tx type, with the proper option configured (-A, -S, SPDIF-mode, or -SAP) to match the receiver.</li> <li>• Check that both units are powered and all necessary cables are firmly connected.</li> <li>• Ensure receiver EQ and SKEW adjustments are set correctly. Use the Auto-adjust mode (push up + down buttons simultaneously). If a manual adjustment is necessary, change EQ settings slowly to avoid losing the picture completely.</li> <li>• During initial installation of a MVII-DVI-Rx-1K receiver, it is best to start by using Auto-Adjust mode. Once you have a video image, it's much easier to fine-tune the EQ setting to get the best possible image on your display.</li> <li>• Make sure the twisted-pair cable is terminated correctly per the TIA/EIA 568B wiring specification.</li> <li>• Check that the display device is powered on and functioning.</li> <li>• Check to ensure your chosen display is compatible with the format of the input signal at the transmitter.</li> </ul>
Poor video quality at receiver	<ul style="list-style-type: none"> <li>• Ensure receiver EQ and SKEW adjustments are set correctly. Change EQ settings slowly while making manual adjustments.</li> <li>• Check all cable connections.</li> <li>• There may be a video-skew delay issue – your cable may have more than 65nSec of skew at its current length. If possible, use a shorter cable (or cut off some excess “service-loop”).</li> <li>• Check the twisted-pair pinout and also the connectors on the transmitter and receiver for any bent pins or foreign objects wedged between contact pins.</li> </ul>
Poor audio quality	<ul style="list-style-type: none"> <li>• The audio output at the receiver is line-level only. An amplifier, or powered speakers, are required. Make sure amplifier or speaker power is ON.</li> <li>• Check input source levels from the source device. Ensure the audio source level does not exceed the audio-input ratings for the transmitter (DVI-Tx). Clipping or distortion can result.</li> <li>• Audio is summed left and right for “-A” mode. If using a single channel, both audio inputs must be connected at the transmitter end to obtain proper audio gain through the link (approximately 1:1, input to output).</li> </ul>
Serial communication doesn't work correctly	<ul style="list-style-type: none"> <li>• Are the serial devices connected properly? Are the serial parameters correct for source/destination devices?</li> <li>• Are the serial cables terminated correctly? Is a null-modem cable required at the TX or RX end?</li> <li>• When using serial-capable receivers with video switches, distribution amps, or multi-output transmitters, the serial data is sent transmit-only. Please take this into account when trying to control displays or other devices. <i>For assistance, contact Technical Support.</i></li> <li>• SAP units have a factory default baud rate of 9600 bps and use 3 wire (TX, RX, GND) signals only. If necessary, use SAP-II serial commands to change the baud rate to match your connected device.</li> </ul>

## Chapter 7 Connector Pinouts

DVI-D connector pinout:

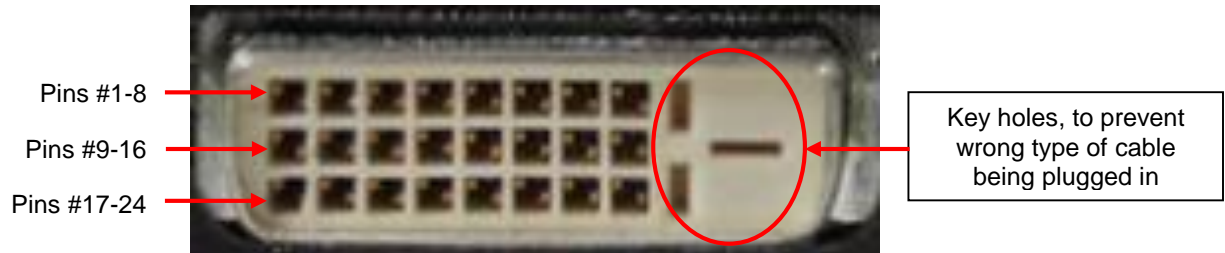

DVI (Digital Visual Interface) is a robust and popular video interface standard that can include digital and analog options in the same connector (the “DVI-I” version). However, as the MVII-DVI-Tx is a digital-video only device, it supports the “DVI-D” subset of the DVI standard interface. The table below provides the pin-out for all 24 pins, which are used in the MVII-DVI-Tx unit.

Pin #	Signal Name
1	TMDS Data 2-
2	TMDS Data 2+
3	TMDS Data 2/4 Shield
4	TMDS Data 4-
5	TMDS Data 4+
6	DDC Clock (SCL)
7	DDC Data (SDA)
8	N/C

Pin #	Signal Name
9	TMDS Data 1-
10	TMDS Data 1+
11	TMDS Data 1/3 Shield
12	TMDS Data 3-
13	TMDS Data 3+
14	+5V Power
15	Ground (for +5V)
16	Hot Plug Detect

Pin #	Signal Name
17	TMDS Data 0-
18	TMDS Data 0+
19	TMDS Data 0/5 Shield
20	TMDS Data 5-
21	TMDS Data 5+
22	TMDS Clock Shield
23	TMDS Clock +
24	TMDS Clock -

## Auxiliary I/O (AUX-I/O) Connector Pinout

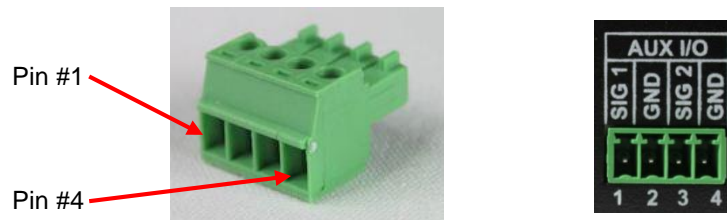

**Figure 7: 4-pin Phoenix Connector Pinout**

**Table 4: Auxiliary I/O (4-pin Phoenix) Pin Usage**

PIN#	(A) Audio	(SAP) Audio	(S) Simplex Serial	SPDIF Audio
1 (SIG1)	Left Channel	Left Channel	Tx	Signal +
2 (GND)	Ground	Ground	ground	Signal -
3 (SIG2)	Right Channel	Right Channel	-	-
4 (GND)	-	-	Shell	-

## Serial port (IOIO) connector pinout (SAP version only):

The DVI-Tx's serial port connector is configured to look like a standard 9-pin "DCE" serial port. Therefore, in most applications a straight through serial cable or adapter-plug (DB9-Female-to-Male) is used to connect an external serial device (for example, a PC) to the DVI-TX transmitter.



*DB9-F Serial Port*



The DB9-F serial port is only available on DVI-TX-SAP model.

	Signal name	DVI-TX (SAP) Simplex	DVI-TX (SAP) Duplex
Pin#	9 wire	2 wire	3 wire
1	DCD	-	-
2	RX	-	RX
3	TX	TX	TX
4	DTR	-	-
5	Ground	Ground	Ground
6	DSR	-	-
7	RTS	-	-
8	CTS	-	-
9	RI	-	-



## RJ45 (MultiView Link) Wiring Standard

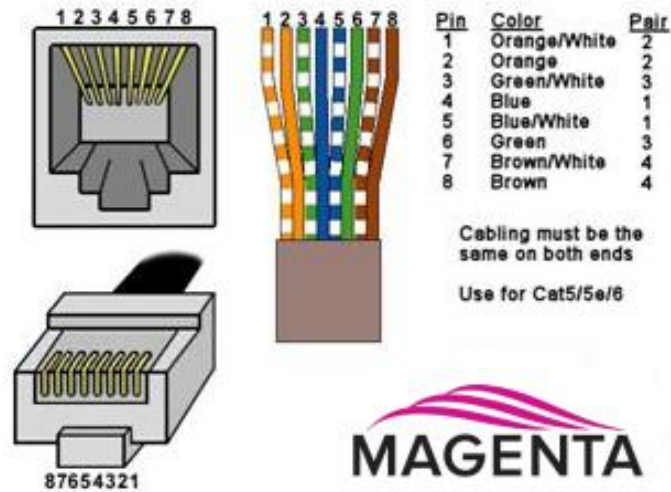
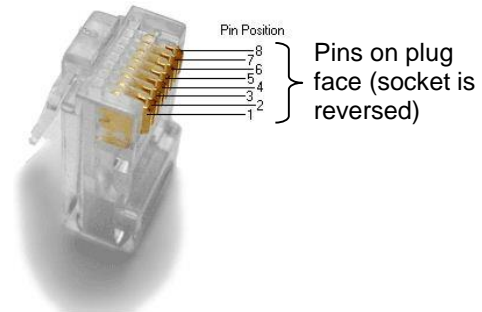

Figure 8: T568B Category Cable Wiring Standard

Table 5: T568B wiring for RJ-45 plug

PIN #	COLOR	PAIR
1	White / Orange Stripe	2
2	Orange Solid	2
3	White / Green Stripe	3
4	Blue Solid	1
5	White / Blue Stripe	1
6	Green Solid	3
7	White / Brown Stripe	4
8	Brown Solid	4

Figure 9: Typical RJ-45 Plug



## DC Power Connector

Magenta provides ready-to-use power supplies for MultiView™ II products. However, if there is a reason a substitute power supply must be used, then the following information is important for maintaining product reliability and performance:

**Magenta AC/DC Power supply output rating:** Regulated +5VDC @ 2.6Amps.

**Power-input rating for MVII-DVI-Tx:** 5VDC, 1.2Amps max.

The DC power input connector accepts an industry-standard coaxial-DC plug with the following specifications:

- Coaxial power connector
- OD = 5.5mm
- ID = 2.5mm (accepted center-pin diameter)
- Length = 11mm (overall length of insertable plug end)
- Inner contact (pin-socket) = +5VDC
- Outer contact (sleeve) = Ground

It is highly recommended that the inner contact (center-pin contact) of any mating DC plug utilize a “tuning-fork” shaped design, rather than a plain barrel shape. The tuning-fork design greatly increases the reliability of the power connection. The plain barrel style connector can cause intermittent operation, often resulting in “mysterious” system problems that are difficult to identify.

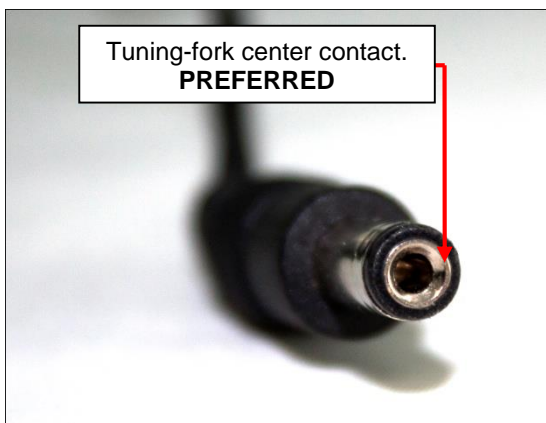

**Figure 10: Plain Barrel Connector**



**Figure 11: Tuning-fork Connector**



The Magenta-provided power supply already comes with the correct output ratings and DC-plug configuration

## Appendix A Supported Video Formats and Features

The following video formats are supported by the MVII-DVI-Tx and MVII-DVI-Rx-1K (combined) link.

Note that while the MVII-DVI-Tx can be used as a source for other types of MultiView receivers with VGA outputs (for example, MVII-AK600DP), not every video format is guaranteed to work with any particular display. Success greatly depends on the display's internal VGA-scaler hardware. Actual testing with the source and display for a specific application is highly recommended before deploying an entire system.

The table below represents the contents of the EDID information stored in the transmitter.

**Table 6: MultiView™ II DVI-Tx + DVI-Rx-1K Supported Video Formats and Features**

Format/Feature	Description
640x480p/59.94&60Hz/24	640x480, progressive scan, 59.94 or 60 Hz, 24 bit color.
720x480p/59.94&60Hz/24	720x480, progressive scan, 59.94 or 60 Hz, 24 bit color
720x576p/50Hz/24	720x576, progressive scan, 50 Hz, 24 bit color
720p/59.94&60Hz/24	1280x720, progressive scan, 59.94 or 60 Hz, 24 bit color.
720p/50Hz/24	1280x720, progressive scan, 50 Hz, 24 bit color.
1080p/60Hz/24	1920x1080, progressive scan, 60 Hz, 24 bit color.
1080p/59.94Hz/24	1920x1080, progressive scan, 59.94 Hz, 24 bit color.
1080p/50Hz/24	1920x1080, progressive scan, 50 Hz, 24 bit color.
1080p/29.97&30Hz/24	1920x1080, progressive scan, 29.97 or 30 Hz, 24 bit color.
1080p/25Hz/24	1920x1080, progressive scan, 25 Hz, 24 bit color.
1080p/23.98&24Hz/24	1920x1080, progressive scan, 23.98 or 24 Hz, 24 bit color.
1080i/59.94&60Hz/24	1920x1080, interlaced scan, 59.94 or 60 Hz, 24 bit color.
1080i/50Hz/24	1920x1080, interlaced scan, 50 Hz, 24 bit color.
Basic Audio	Digital audio (2-Channel PCM) de-embedding is supported at the DVI-Tx end. On the DVI-Rx-1K end, digital audio is provided as a S/PDIF (copper interface) stream on the Aux-I/O connector.

## Appendix B (SAP) Option Module Settings

The SAP option module allows a bi-directional session to be established between a SAP-equipped transmitter (MVII-DVI-Tx-SAP), and a specific SAP-equipped receiver even in a multiple-receiver daisy chain installation.

The SAP transmitter devices (MVII-DVI-Tx-SAP for example) do not have address DIP-switches. The factory-default address of the transmitter is “0”.

The SAP receiver devices (MVII-DVI-Rx-1K-SAP for example) have address DIP-switches.

Each SAP-equipped receiver must have a unique address set first, via DIP-switch settings or by a serial command entered directly at the receiver.

Once this has been done, a special “set destination address” command is sent into the transmitter to specify which receiver to open a session with.

If the transmitter is commanded to use destination address 0 (zero), serial data will be broadcast to all receivers. This is the factory-default behavior.

To set the SAP receiver’s address switches, you will need to open the **receiver** enclosure and set the DIP-switches directly on the SAP module. The DIP-switch has 8 switches, one for each address bit position. Use the SAP addressing chart provided on the next page to determine the proper switch addresses.

All receivers must have a unique address. *It is recommended to write the address on each receiver once this step has been completed.* It is also recommended to keep a list of receiver addresses and locations to make it easier to determine which receiver/display is desired to communicate with.

### To set SAP address DIP-switches (at SAP-receiver units):

1. Remove the top cover assembly of the receiver.
2. Locate the 8 position dipswitch on the internal daughterboard assembly and using the SAP-addressing chart, set the receiver address as needed.

**Figure 12: Internal Daughterboard Assembly with 8 Position Dipswitch**

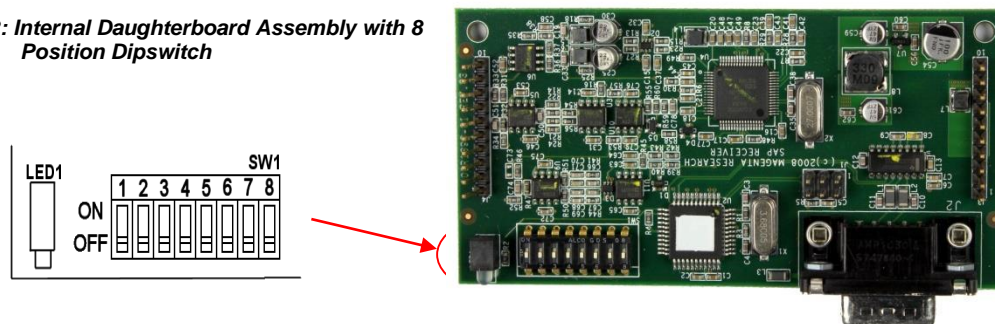

3. Replace cover assembly and install unit.

**Note:** It is also possible to set a SAP receiver’s address by a **serial-command** entered at the receiver itself. In this case, simply ensure all DIP switches are set to address 0 (zero).

Please also refer to the *SAP II Programmer’s Guide* for additional information on SAP related settings and operation.

## Appendix C



## Pollable Serial Mode Address Chart

ADDR	Switch Settings	
00	1 2 3 4 5 6 7 8	ON
		OFF
01	1	ON
	2 3 4 5 6 7 8	OFF
02	2	ON
	1 3 4 5 6 7 8	OFF
03	1 2	ON
	3 4 5 6 7 8	OFF
04	3	ON
	1 2 4 5 6 7 8	OFF
05	1 3	ON
	2 4 5 6 7 8	OFF
06	2 3	ON
	1 4 5 6 7 8	OFF
07	1 2 3	ON
	4 5 6 7 8	OFF
08	4	ON
	1 2 3 5 6 7 8	OFF
09	1 4	ON
	2 3 5 6 7 8	OFF
10	2 4	ON
	1 3 5 6 7 8	OFF
11	1 2 4	ON
	3 5 6 7 8	OFF
12	3 4	ON
	1 2 5 6 7 8	OFF
13	1 3 4	ON
	2 5 6 7 8	OFF
14	2 3 4	ON
	1 5 6 7 8	OFF
15	1 2 3 4	ON
	5 6 7 8	OFF
16	5	ON
	1 2 3 4 6 7 8	OFF
17	1 5	ON
	2 3 4 6 7 8	OFF
18	2 5	ON
	1 3 4 6 7 8	OFF
19	1 2 5	ON
	3 4 6 7 8	OFF
20	3 5	ON
	1 2 4 6 7 8	OFF
21	1 3 5	ON
	2 4 6 7 8	OFF
22	2 3 5	ON
	1 4 6 7 8	OFF
23	1 2 3 5	ON
	4 6 7 8	OFF
24	4 5	ON
	1 2 3 6 7 8	OFF
25	1 4 5	ON
	2 3 6 7 8	OFF
26	2 4 5	ON
	1 3 6 7 8	OFF
27	1 2 3 4 5	ON
	6 7 8	OFF
28	3 4 5	ON
	1 2 6 7 8	OFF
29	1 3 4 5	ON
	2 6 7 8	OFF
30	2 3 4 5	ON
	1 6 7 8	OFF
31	1 2 3 4 5	ON
	6 7 8	OFF
32	6	ON
	1 2 3 4 5 7 8	OFF
33	1 6	ON
	2 3 4 5 7 8	OFF
34	2 6	ON
	1 3 4 5 7 8	OFF
35	1 2 6	ON
	3 4 5 7 8	OFF
36	3 6	ON
	1 2 4 5 7 8	OFF
37	1 3 6	ON
	2 4 5 7 8	OFF
38	2 3 6	ON
	1 4 5 7 8	OFF
39	1 2 3 6	ON
	4 5 7 8	OFF
40	4 6	ON
	1 2 3 5 7 8	OFF
41	1 4 6	ON
	2 3 5 7 8	OFF
42	2 4 6	ON
	1 3 5 7 8	OFF
43	1 2 4 6	ON
	3 5 7 8	OFF
44	3 4 6	ON
	1 2 5 7 8	OFF
45	1 3 4 6	ON
	2 5 7 8	OFF
46	2 3 4 6	ON
	1 5 7 8	OFF
47	1 2 3 4 6	ON
	5 7 8	OFF
48	5 6	ON
	1 2 3 4 7 8	OFF
49	1 5 6	ON
	2 3 4 7 8	OFF
50	2 5 6	ON
	1 3 4 7 8	OFF
51	1 2 5 6	ON
	3 4 7 8	OFF
52	3 5 6	ON
	1 2 4 7 8	OFF
53	1 3 5 6	ON
	2 4 7 8	OFF
54	2 3 5 6	ON
	1 4 7 8	OFF
55	1 2 3 5 6	ON
	4 7 8	OFF
56	4 5 6	ON
	1 2 3 7 8	OFF
57	1 4 5 6	ON
	2 3 7 8	OFF
58	2 4 5 6	ON
	1 3 7 8	OFF
59	1 2 3 4 5 6	ON
	7 8	OFF
60	3 4 5 6	ON
	1 2 7 8	OFF
61	1 3 4 5 6	ON
	2 7 8	OFF
62	2 3 4 5 6	ON
	1 7 8	OFF
63	1 2 3 4 5 6	ON
	7 8	OFF
64	7	ON
	1 2 3 4 5 6 8	OFF
65	1 7	ON
	2 3 4 5 6 8	OFF
66	2 7	ON
	1 3 4 5 6 8	OFF
67	1 2 7	ON
	3 4 5 6 8	OFF
68	3 7	ON
	1 2 4 5 6 8	OFF
69	1 3 7	ON
	2 4 5 6 8	OFF
70	2 3 7	ON
	1 4 5 6 8	OFF
71	1 2 3 7	ON
	4 5 6 8	OFF
72	4 7	ON
	1 2 3 5 6 8	OFF
73	1 4 7	ON
	2 3 5 6 8	OFF
74	2 4 7	ON
	1 3 5 6 8	OFF
75	1 2 4 7	ON
	3 5 6 8	OFF
76	3 4 7	ON
	1 2 5 6 8	OFF
77	1 3 4 7	ON
	2 5 6 8	OFF
78	2 3 4 7	ON
	1 5 6 8	OFF
79	1 2 3 4 7	ON
	5 6 8	OFF
80	5 7	ON
	1 2 3 4 6 8	OFF
81	1 5 7	ON
	2 3 4 6 8	OFF
82	2 5 7	ON
	1 3 4 6 8	OFF
83	1 2 5 7	ON
	3 4 6 8	OFF
84	3 5 7	ON
	1 2 4 6 8	OFF
85	1 3 5 7	ON
	2 4 6 8	OFF
86	2 3 5 7	ON
	1 4 6 8	OFF
87	1 2 3 5 7	ON
	4 6 8	OFF
88	4 5 7	ON
	1 2 3 6 8	OFF
89	1 4 5 7	ON
	2 3 6 8	OFF
90	2 4 5 7	ON
	1 3 6 8	OFF
91	1 2 3 4 5 7	ON
	6 8	OFF
92	3 4 5 7	ON
	1 2 6 8	OFF
93	1 3 4 5 7	ON
	2 6 8	OFF
94	2 3 4 5 7	ON
	1 6 8	OFF
95	1 2 3 4 5 7	ON
	6 8	OFF
96	6 7	ON
	1 2 3 4 5 8	OFF
97	1 6 7	ON
	2 3 4 5 8	OFF
98	2 6 7	ON
	1 3 4 5 8	OFF
99	1 2 6 7	ON
	3 4 5 8	OFF
100	3 6 7	ON
	1 2 4 5 8	OFF
101	1 3 6 7	ON
	2 4 5 8	OFF
102	2 3 6 7	ON
	1 4 5 8	OFF
103	1 2 3 6 7	ON
	4 5 8	OFF
104	4 6 7	ON
	1 2 3 5 8	OFF
105	1 4 6 7	ON
	2 3 5 8	OFF
106	2 4 6 7	ON
	1 3 5 8	OFF
107	1 2 4 6 7	ON
	3 5 8	OFF
108	3 4 6 7	ON
	1 2 5 8	OFF
109	1 3 4 6 7	ON
	2 5 8	OFF
110	2 3 4 6 7	ON
	1 5 8	OFF
111	1 2 3 4 6 7	ON
	5 8	OFF
112	5 6 7	ON
	1 2 3 4 8	OFF
113	1 5 6 7	ON
	2 3 4 8	OFF
114	2 5 6 7	ON
	1 3 4 8	OFF
115	1 2 5 6 7	ON
	3 4 8	OFF
116	3 5 6 7	ON
	1 2 4 8	OFF
117	1 3 5 6 7	ON
	2 4 8	OFF
118	2 3 5 6 7	ON
	1 4 8	OFF
119	1 2 3 4 5 6 7	ON
	8	OFF
120	4 5 6 7	ON
	1 2 3 8	OFF
121	1 4 5 6 7	ON
	2 3 8	OFF
122	2 4 5 6 7	ON
	1 3 8	OFF
123	1 2 3 4 5 6 7	ON
	8	OFF
124	3 4 5 6 7	ON
	1 2 8	OFF
125	1 3 4 5 6 7	ON
	2 8	OFF
126	2 3 4 5 6 7	ON
	1 8	OFF
127	1 2 3 4 5 6 7	ON
	8	OFF



## Appendix D Mounting Kits

There are several kits available for mounting the DVI-TX:

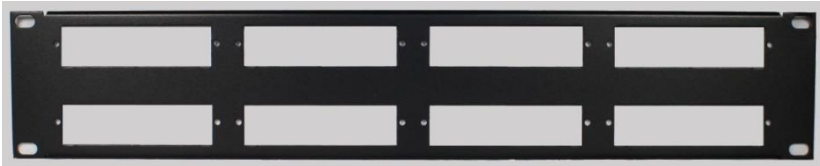
Mounting Kit #	Description	
2211053-01	Rigid-mount bracket. This mounts a single device to a surface (wall/desk/etc.). Comes with 4 self-tapping screws.	
8310207-01	1U Rack-mount Plate for standard 19" rack. Mounts 4 devices in a 1U space. Comes with (8) device-mounting screws, (4) rack-mounting screws.	
8310208-01	2U Rack-mount Plate for standard 19" rack. Mounts 8 devices in a 2U space. Comes with (16) device-mounting screws, (4) rack-mounting screws.	

**Note:** When installing DVI-TX devices in an area susceptible to elevated operating temperatures (near the maximum specified operating temperature), it is important to give careful consideration to maintaining adequate air flow. Within a rack assembly, cable bundles and other equipment in the same rack can impede proper cooling. In some rack-mount applications you may even need to leave a 1U gap (using a blank filler plate) between DVI-TX groups. For surface-mount applications, ensure the device will have adequate air circulation and that air-vents on the enclosure are not blocked.

*DVI-TX with Rigid-mount Bracket:*



*DVI-TX with 2U Rack-mount Plate:*



*DVI-TX with 1U Rack-mount Plate:*







## Appendix E      **Magenta Equipment Compatibility**



The “SAP bidirectional serial data” becomes unidirectional (source → display) if the link is run through Mondo-III, MultiView-8x8 (and 16x16) switches, or through the MultiView 9D distribution amplifier.



Using a Magenta Switch to change sources will cause the picture to drop out for ~10 seconds if the MultiView II DVI Rx is in Auto EQ mode. To avoid this issue, ensure the MultiView II DVI Rx is configured for Manual EQ once a good picture has been established during installation.

### **MONDOIII Switch**

The input cable length to the unit can be any length. Note that while the input cables can be any length, the Mondo-III system configuration guidelines for “normalizing input cable lengths” still apply.

The output cable length from the unit can be any length.

The total (input + output cable) length must not exceed the 1000ft range of the MultiView II DVI units.

### **MultiView Matrix 8x8 and 16x16 Switches**

The input cable length to the unit must not exceed 400ft.

The output cable length from the unit can be any length.

Note, using a MultiView Matrix has a small impact on the total cable length possible, the total (input + output cable) length must not exceed the 900ft.

### **MultiView 9D Distribution Amplifier**

The input cable length to the unit can be any length.

The output cable length from the unit can be any length.

The total (input + output cable) length must not exceed the 1000ft range of the MultiView II DVI units.

Note, the MultiView II DVI units have a maximum range of 1000ft, using a MultiView 9D will not increase the range to the 1400ft as quoted in the MultiView 9D manual.

## Index

About this manual, 4

Adjustments, 11

EQ setting, 11

Skew setting, 12

Auxiliary I/O connector, 18

Configuration

4<sup>th</sup>-pair Modes, 15

Factory defaults, 13

general, 12

Sync modes, 14

Connectors

auxiliary I/O, 18

DC power, 21

DVI Port, 17

Link (RJ45), 20

Default Settings, 13

Front panel interfaces, 5

Installation, 8

prerequisites, 8

procedure, 8

SAP Module Configuration, 8

Mounting kits, 26

Option module settings

SAP option module, 23

Pinouts

Serial Port, 19

Pollable serial mode

addressing chart, 24

Precautions, iv

Product Overview, 5

Rear panel interfaces, 6

Regulatory Information, 3

Reset to factory defaults, 13

SAP addressing chart, 24

Specifications, 1

Auxiliary signals, 2

DDC/EDID Support, 2

DVI Interface, 1

Supported Video Formats and Features, 22

Troubleshooting, 16

Twisted Pair Cables, 7

# NOTES:



2791 Circleport Drive, Erlanger, KY 41018, USA.

Americas: 859-282-7303

EMEA: +44 (0) 1843 873322

Email: [tech.usa@tvone.com](mailto:tech.usa@tvone.com)

[www.tvone.com](http://www.tvone.com)