

# MultiView™ II AK600/AK1200 Receiver: Quick Start Guide MAGENTA

The Magenta MultiView™ II AK600 and AK1200 receivers extend video, audio, and serial signals over standard CAT cable. There are user-configurable settings for video, audio, and serial options which can be controlled from the front panel. For more details please refer to the complete **MultiView™ II AK600/1200 User Guide**, available for download at <http://www.tvone.com>.

**Required Tools / Hardware / Materials:** Tools include appropriate screwdriver(s) and mounting hardware (optional, for example: rack-mount, wall or under-desk mounting). Required materials include appropriate cables for your specific application.

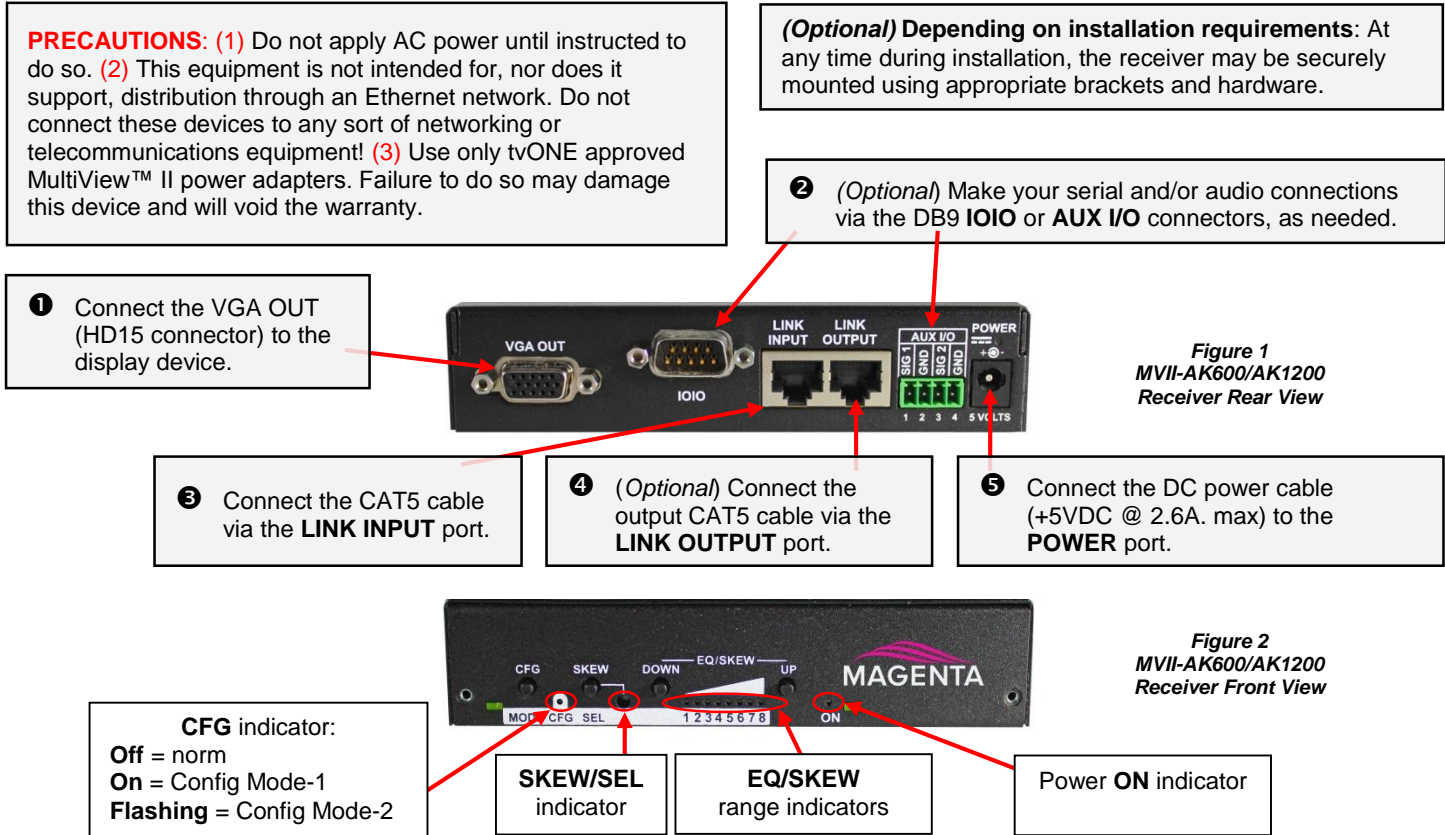

**Power-up Check:** After all signal and power cables are connected, apply AC power. The power ON indicator should light. If there is a local monitor attached, a video image should appear on the monitor. If there is no image on the display, recheck all cables and ensure the display is turned on. Also check that the EQ is properly set – this is most often the case when there is no image on the display.

**Front Panel Controls:** (Refer to Figure-2) There are four buttons (**CFG/MODE**, **SKEW/SEL**, **DOWN** and **UP**), and several green LED status indicators. These are used to control the operating modes of the receiver, and to display current status.

**Status Indicators at power-up:** When the unit is first powered on, the status indicators will cycle through a test sequence, then display the current EQ setting on LEDs 1-8. This is the “normal” mode of operation:

- ❖ POWER ON indicator is on.
- ❖ CFG indicator is off.
- ❖ SKEW/RGB indicator is off.
- ❖ EQ/SKEW indicators display current EQ settings (0 to 100%).

As previously noted, it is critical that the EQ setting be adjusted to compensate for the length of CAT cable leading back to the transmitter. Skew compensation adjustment (if your unit is equipped with an AkuComp-II module) will also be important for best image quality.

**EQ Adjustment:** When the unit is operating in normal mode (CFG indicator is off), it is possible to quickly adjust the EQ. The **EQ/SKEW** indicators 1-8 will change accordingly to show 0 to 100% of the adjustment range.

(starting in normal-mode)

- 1** Press and hold the **UP** or **DOWN** button until the **SKEW/RGB** indicator turns on (VIOLET). Release the **UP** or **DOWN** button.
- 2** Press the **UP** or **DOWN** buttons repeatedly to adjust the EQ setting, either one step at a time or hold for auto-repeat.
- 3** To exit EQ-ADJUST mode, leave the buttons untouched for 10 seconds, or press the **CFG** button once.

**Note:** For best results, use the Magenta EQ/Skew “test pattern” image if possible. This is available from the tvONE website.

**Skew Adjustment:** If the AkuComp-II skew module is installed, it is possible to quickly adjust the RGB values when the unit is operating in normal mode. The **EQ/SKEW** indicators 1-8 will show the current setting as 0-100% of the SKEW adjustment range. (starting in normal-mode)

- ❶ **RED skew adjust:** Press and hold the **SKEW/SEL** button until the **SKEW/RGB** indicator turns on RED. Release the SKEW button.
- ❷ Press the **UP** or **DOWN** button repeatedly to adjust the RED skew value.
- ❸ **GREEN skew adjust:** Press and release the **SKEW/SEL** button. The **SKEW/RGB** indicator will turn GREEN.
- ❹ Press the **UP** or **DOWN** button repeatedly to adjust the GREEN value.
- ❺ **BLUE skew adjust:** Press and release the **SKEW/SEL** button. The **SKEW/RGB** indicator will turn BLUE.
- ❻ Press the **UP** or **DOWN** button to adjust the BLUE value.
- ❼ Pressing the **SKEW/SEL** button again will return you to step-2, allowing adjustment of the RED skew again.
- ❽ To exit SKEW-ADJUST mode, leave the buttons untouched for 10 seconds or press the **CFG** button.

**Note:** For best results, use the Magenta EQ/Skew “test pattern” image if possible. This is available from the tvONE website.

**Changing Internal Settings:** In configuration-mode (**CFG** indicator = on or flashing), the **CFG** and **SKEW/SEL** buttons, plus the LED indicators (1-8) will allow you to change internal configuration settings. The changes are effective immediately and are saved in non-volatile memory.



- ❖ **To enter configuration-mode:** Press and hold the **CFG** button until the **CFG** indicator is **ON**. Once in this mode, LEDs 1-8 will display the current settings as described in the tables below. You are now at configuration menu level-1.
- ❖ **To exit configuration-mode:** Leave the buttons untouched for 10 seconds or press the **CFG** button again. The **CFG** indicator will turn off (normal-mode).

**Note:** There are two configuration modes. CFG(on) = Mode-1, CFG(flashing) = Mode-2.

**Configuration Mode-1, Sync-mode Options:** The unit is factory-configured for auto-detecting the proper sync-mode (RepliSync-I normal/stretched). This mode is generally compatible with all existing MultiView transmitter and receiver products that support RepliSync (if they are also using their default settings). However, some video sources may require a custom sync-mode setting (especially at 1080p and 1920x1200 video resolutions). For these cases, one of the other sync-modes can be selected. Note that any connected MultiView device (transmitter or daisy-chained receiver) **MAY** also require a change to its sync-mode settings. Otherwise, you may not get a proper video display output at one or more receivers.

(starting in normal-mode)

- ❶ Press and hold the **CFG** button until the **CFG** indicator is **ON**. Release the **CFG** button.
  - LEDs 1-8 will show the current value for all Mode-1 configuration settings as **bright** (same as **ON**), **dim** (same as **OFF**).
- ❷ Press and release the **SKEW/SEL** button once.
- ❸ **LED indicators 1 and 2** should be illuminated (either ON or DIM); all others (indicators 3-8) should be off.
- ❹ Press the **UP** and **DOWN** buttons to step through the available sync-mode settings as shown below.
- ❺ To leave configuration-mode, leave the buttons untouched for 10 seconds or press the **CFG** button.

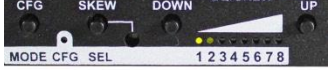



LED1	LED2	Front Panel View	Sync-mode Setting
dim	dim		The unit will auto-detect the required RepliSync-I mode (“normal” or “stretched”). This is the <u>factory-default</u> setting.
dim	ON		Force RepliSync-II mode. This is compatible with MultiView II “RepliSync-II” mode only (when connected to a MultiView-II transmitter).
ON	dim		Force fixed-sync mode. <b>NOTE:</b> The source MultiView transmitter must also be in fixed-sync mode. Note that H/V polarity settings must also be selected at each receiver.

**Note:** There is no CFG1 parameter for LED3.

**Configuration Mode-1, 4<sup>th</sup> Pair Options:** The unit provides several options for using the 4<sup>th</sup>-pair signals (pairs 1-3 are generally used for video). The factory-default settings support analog audio (L+R summed) on the 4<sup>th</sup>-pair. Note that the connected MultiView transmitter and any daisy-chained receivers must be configured with a matching 4<sup>th</sup>-pair operating mode. Otherwise, the desired 4<sup>th</sup>-pair signal will not work as expected – but the video will not be affected.

(starting in normal-mode)

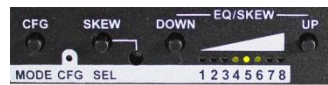
- ➊ Press and hold the **CFG** button until the **CFG** indicator is **ON**. Release the **CFG** button.
- ➋ LEDs 1-8 will show the current value for all Mode-1 configuration settings as ON/DIM.
- ➌ Press and release the **SKEW/SEL** button twice.
- ➍ **LED indicators 4-6** should be illuminated (either DIM or ON); all others (indicators 1-3, 7 and 8) should be off.
- ➎ Press the **UP** and **DOWN** buttons to step through the available 4<sup>th</sup>-pair settings as shown below.
- ➏ To leave configuration-mode, leave the buttons untouched for 10 seconds or press the **CFG** button.

LED4	LED5	LED6	Front Panel View	4 <sup>th</sup> -pair Operating Mode
dim	dim	dim		<b>If option-module is installed:</b> 4 <sup>th</sup> -pair operating mode is defined by the presence of the option-module (SAP) and this setting cannot be changed. <b>If the option-module is not installed:</b> 4 <sup>th</sup> -pair signals are disabled. This effectively "mutes" anything being sent on the 4 <sup>th</sup> pair. This can be useful for diagnostic purposes.
dim	dim	ON		Direct pass-through of 4 <sup>th</sup> -pair wires (custom applications).
<b>dim</b>	<b>ON</b>	<b>dim</b>		<b>External analog (L+R summed) audio ("-A" mode).</b> <b>This is the factory-default mode if no daughterboard option is installed.</b> (Remember to also check 4 <sup>th</sup> -pair termination setting)
dim	ON	ON		External S/PDIF digital audio. Output-impedance = 75-ohms. (Remember to also check 4 <sup>th</sup> -pair termination setting)
ON	dim	dim		Simplex-serial ("-S" mode) (Remember to also check 4 <sup>th</sup> -pair termination setting)

**Configuration Mode-1, Vsync Polarity:** The unit provides settings for Vsync polarity: (+) or (-).

(starting in normal mode)

- ➊ Press and hold the **CFG** button until the **CFG** indicator is **ON**. Release the **CFG** button.
  - LEDs 1-8 will show the current value for all Mode-1 configuration settings as ON/DIM.
- ➋ Press and release the **SKEW/SEL** button three times.
- ➌ **LED indicator 7** should be illuminated (either DIM or ON); all others (indicators 1-6 and 8) should be off.
- ➍ Press the **UP** and **DOWN** buttons to change Vsync polarity from Positive (**ON**) to Negative (**DIM**).
- ➎ To leave configuration-mode, leave the buttons untouched for 10 seconds or press the **CFG** button.

**Note:** This setting only has an effect if the sync-mode is set to "Fixed".

**Configuration Mode-1, Hsync Polarity:** The unit provides settings for Hsync polarity: (+) or (-).

(starting in normal mode)



- ➊ Press and hold the **CFG** button until the **CFG** indicator is **ON**. Release the **CFG** button.
  - LEDs 1-8 will show the current value for all Mode-1 configuration settings as ON/DIM.
- ➋ Press and release the **SKEW/SEL** button four times.
- ➌ **LED indicator 8** should be illuminated (either DIM or ON); all others (indicators 1-7) should be off.
- ➍ Press the **UP** and **DOWN** buttons to change Hsync polarity from Positive (**ON**) to Negative (**DIM**).
- ➎ To leave configuration-mode, leave the buttons untouched for 10 seconds or press the **CFG** button.

**Note:** This setting only has an effect if the sync-mode is set to "Fixed".

**Configuration Mode-2, Clamp-Mode:** The unit allows you to select the video clamp-mode.

(starting in normal-mode)

- ❶ Press and hold the **CFG** button until the **CFG** indicator is **ON**. Release the **CFG** button.
  - LEDs 1-8 will show the current value for all Mode-1 configuration settings as ON/DIM.
- ❷ Press and release the **SKEW/SEL** button five times. The **CFG** indicator will start **flashing**.
  - LEDs 1-8 will show the current value for all Mode-2 configuration settings as ON/DIM.
- ❸ Press and release the **SKEW/SEL** button once.
- ❹ **LED indicators 1 and 2** should be illuminated (either DIM or ON); all others (indicators 3-8) should be off.
- ❺ Press the **UP** and **DOWN** button repeatedly to step through the available video-option settings as shown below.
- ❻ To leave configuration-mode, leave the buttons untouched for 10 seconds or press the **CFG** button.

LED1	LED2	Front Panel View	Clamp-mode Settings
dim	dim		<b>Auto-detect the required clamp-mode based on the video signal format. This is the <u>factory-default</u> mode.</b>
dim	ON		Force clamp-mode Off. If needed, this is the preferred setting for component/composite video.
ON	dim		Force clamp-mode On. If needed, this is the preferred setting for RGBHV (VGA) video.

**Note:** The default **auto-detect** clamp-mode setting will usually work for any RGBHV(VGA), component or composite video signal being received from a MultiView transmitter. However, in some cases it may be necessary to manually select either the **OFF** or **ON** setting: **OFF** is preferred for component & composite signals; **ON** is preferred for RGBHV(VGA) signals.

**Configuration Mode-2, 4<sup>th</sup> Pair Termination:** The unit provides settings for 4<sup>th</sup> pair termination: **ON** or **OFF**. This setting has an effect only for “-S”, “-A” and S/PDIF operating modes. **Note:** It is not possible to access the 4<sup>th</sup>-pair setting if an option board is installed – since this setting is ignored.

- Set to **ON** for all **single-receiver** applications, and for the **last receiver** in a daisy-chained configuration.
  - This is the factory-default.
- Set to **OFF** only for **mid-span** receivers in a daisy-chain configuration.

(starting in normal-mode)

- ❶ Press and hold the **CFG** button until the **CFG** indicator is **ON**.
  - LEDs 1-8 will show the current value for all Mode-1 configuration settings as ON/DIM.
- ❷ Press and release the **SKEW/SEL** button five times. The **CFG** indicator will start **flashing**.
  - LEDs 1-8 will show the current value for all Mode-2 configuration settings as ON/DIM.
- ❸ Press and release the **SKEW/SEL** button twice.
- ❹ **LED indicator 3** should be illuminated (either DIM or ON); all others (indicators 1, 2 and 4-8) should be off.
- ❺ Press the **UP** and **DOWN** button repeatedly to turn 4<sup>th</sup>-pair termination ON (**ON**) or OFF (**DIM**).
- ❻ To leave configuration-mode, leave the buttons untouched for 10 seconds or press the **CFG** button.

**To reset all user-configurable options back to factory-default settings:**

- ❶ Disconnect the DC power cable (or AC power).
- ❷ Press and hold the **CFG** button.
- ❸ Connect the DC power cable (or AC power). All LEDs (except the “on” LED) will blink 3 times.
  - All settings are now changed back to factory-defaults.
- ❹ Release the **CFG** button.

**Troubleshooting:** In many cases, problems encountered when installing MultiView™ II extension products can be resolved by checking the CAT cable termination. It must be pinned out according to the TIA/EIA 568B standard wiring specification. For additional troubleshooting information or to obtain the TIA/EIA 568B wiring specifications please refer to the MVII-AK600/1200 User Guide, downloadable from <http://www.tvone.com>.