



**C2-2375A
Universal Scaler PLUS
Operation Manual**

C2-2375A SERIES OPERATION MANUAL

TABLE OF CONTENTS

1	DISCLAIMER	1
1.1	Regulatory Agency Acceptance.....	1
1.2	FCC Statement.....	1
1.3	Manual Version Information.....	2
1.4	Manual Copyright Notice	2
2	IMPORTANT SAFETY INSTRUCTIONS	3
3	CAPABILITY, DEVICE FEATURES AND PRODUCT FEATURES	19
3.1	Device Capabilities.....	19
3.2	Device Features	19
4	PRODUCT IMAGES	21
5	UNPACKING AND INSTALLATION	22
5.1	Shipping Carton.....	22
5.2	Important Safety Instructions	22
5.3	Initial Operation Check Using Factory Default Settings.....	22
6	FRONT PANEL CONTROLS	23
6.1	Button controls	23
6.2	Special button combinations and functions.....	24
6.2.1	Saving current settings	25
6.2.2	Locking front panel buttons & IR remote control	25
6.2.3	Restore power-on settings.....	25
6.2.4	Factory Reset	25
7	VIDEO INPUTS AND OUTPUTS	26
7.1	Computer & Video inputs.....	26
7.2	Computer & Video outputs.....	27
7.3	SDI inputs and outputs	27
7.4	GENLOCK input.....	28
7.5	Audio.....	28
7.6	System block diagram	28
8	MENU LAYOUT AND SETTINGS ADJUSTMENT	29
8.1	Group Names and Descriptions.....	30
8.2	Adjust presets menu item	31
8.3	Items Associated with the Adjust outputs group.....	31
8.4	Items Associated with the Adjust windows group.....	35
8.4.1	Extended scaling controls.....	39

C2-2375A SERIES OPERATION MANUAL

8.4.2	'Aspect adjust' = 'Advanced'	40
8.4.3	'Aspect adjust' = 'Pixel'	40
8.5	Items Associated with the Adjust keyers group.....	41
8.6	Items Associated with the Adjust sources group.....	43
8.6.1	Menu items common to all inputs	43
8.6.2	DVI Source Menu Items	46
8.6.3	RGB Source Menu Items.....	48
8.6.4	CV & YC Source Menu Items	49
8.6.5	Still Image Store / Testcard Source Menu Items.....	50
8.7	Items associated with the Adjust transitions group.....	50
8.8	Items associated with the Adjust ethernet group.....	51
8.9	Items associated with the Adjust resolutions group.....	53
8.10	Items Associated with the System group	56
9	SERIAL PORT	61
9.1	Connection	61
9.2	Communications protocol	61
10	SERIAL / IP CONTROL SPECIFICATION	63
10.1	Communication protocol basics	63
10.2	Packet format	64
10.3	Function list	66
10.4	Examples	74
10.5	Reading and writing macros	75
10.5.1	Reading a previously stored Macro	76
10.5.2	Writing to a macro	76
10.5.3	Run and Restore macros.....	77
10.5.4	Emulate a front panel button press.....	77
10.5.5	Reset command	82
	COMMON OPERATIONS	83
10.6	Operation of the Keyer	83
10.6.1	Preparation:.....	83
10.6.2	Adjustment:	83
11	TROUBLESHOOTING AND TECHNICAL SUPPORT	85
11.1	There is no picture on the Output	85
11.2	The image is shifted and not fully viewable.....	85
11.3	The output resolutions no longer appear as expected.	85
11.4	There is excessive flicker on the Output	86

C2-2375A SERIES OPERATION MANUAL

11.5	The Output image is distorted.....	86
11.6	Some colors appear to be incorrect on the CV/YC output.....	86
11.7	How can I reduce color smearing on CV connections?.....	86
11.8	I can no longer adjust the Output image resolution.....	86
11.9	The picture on the video display is black and white.	86
11.10	The picture on the video display is green.....	86
11.11	The RGB input is selected but the image is rolling or pink.	87
11.12	The video signal from my DVD player does not appear to work.....	87
11.13	Image is flashing, snow is present, or source image does not appear.	87
12	RETURN PROCEDURE	88
12.1	Are you sure there's a fault?	88
12.2	To return a unit for repair.....	88
13	WARRANTY POLICY	90
14	CONNECTOR PINOUTS	91
14.1	DVI-U connector.....	91
14.2	RS232/422/485 D9 socket.....	91
15	SPECIFICATIONS	93
15.1	Video Inputs	93
15.2	Reference Input.....	93
15.3	Computer Digital Inputs	93
15.4	Analog inputs.....	93
15.5	Video Outputs.....	93
15.6	Computer Digital Outputs	94
15.7	Analog Outputs.....	94
15.8	SDI inputs & outputs.....	94
15.9	Locking/Mixing.....	94
15.10	Scaling / sampling / memory.....	94
15.11	Reliability.....	95
15.12	Warranty.....	95
15.13	Regulatory Compliance	95
15.14	Environmental	95
15.15	Power Requirement.....	95
15.16	Control Methods.....	95
15.17	Accessories Included.....	95
15.18	Mechanical	95
15.19	Optional Accessories.....	95

C2-2375A SERIES OPERATION MANUAL

16 CONTACT INFORMATION..... 96

1 DISCLAIMER

This product is intended for professional and/or home use. This product is not intended for use in a medical environment and does not have the required certifications for such use. Similarly, use aboard any aircraft or spacecraft while in flight or as an adjunct to any surface, airborne or marine navigation system or any offshore marine activity, including control of any watercraft, or any use similar to those specifically herein mentioned is prohibited. Use in the aforementioned circumstances would require additional testing and certification.

You have not become the owner of any software - you have merely purchased the right to use the software. You may make one copy of the software for your own use. Other copies will be deemed a breach of copyright.

No warranty is made either expressed or implied including but not limited to any implied warranties of merchantability or fitness for a particular purpose. In no event shall the supplier or manufacturer of this product be liable for errors found within, or be liable for any direct, indirect or consequential damages or loss in connection with the purchase or use of this hardware software or manual. The sole and exclusive liability to the supplier and manufacturer regardless of the form of action shall not exceed the replacement cost of the materials described herein.

By using this equipment you have indicated that you have agreed to the terms listed above. If you do not wish to agree or the above terms are contrary to your conditions of purchase you may return the equipment, unused, to your supplier. All trademarks and copyrights are acknowledged. E&OE.

1.1 Regulatory Agency Acceptance

European 'CE' Mark Statement

Emissions: BS EN 61000-6-3:2001 (Generic Immunity Standard for Residential, Commercial and Light Industrial)

Immunity: BS EN 61000-6-1:2001 (Generic Immunity Standard for Residential, Commercial and Light Industrial)

1.2 FCC Statement

Class A Device: This equipment has been tested and found to comply with the limits for a Class A digital device pursuant to Part 15 of the FCC Rules. These limits are designed to provide a reasonable protection against harmful interference when the equipment is operated in a commercial environment. This equipment generates, uses and can radiate radio frequency energy and, if not installed and used in accordance with the Instruction Manual, may cause harmful interference to radio communications. Operation of this equipment in a residential area is likely to cause harmful interference in which case the user will be required to correct the interference at his own expense.

C2-2375A SERIES OPERATION MANUAL

Caution: This equipment is intended for use in the manner prescribed in the Instruction Manual. Any user changes or modifications not expressly approved by TV One Multimedia Solutions could void the user's authority to operate the equipment. Connecting this equipment to external devices requires no specially shielded cabling for FCC compliance. The Instruction Manual shows or describes the proper connection of this equipment for operation that insures FCC compliance.

Direct all inquiries regarding FCC compliance to:

TV One Multimedia Solutions
2791 Circleport Drive
Erlanger, KY 41018
USA
Tel 859-282-7303
Fax 859-282-8225

1.3 Manual Version Information

Version: 2.14
Release Date: November, 2010

1.4 Manual Copyright Notice

This Operation Manual is the intellectual property of TV One, ©2006, 2007, 2008, 2009, 2010. No portion of this manual may be copied or reproduced in any manner or by any means, including, but not limited to electronic and electro-mechanical, without the express written permission of TV One.

2 IMPORTANT SAFETY INSTRUCTIONS

To insure the best from this product, please read this manual carefully.

- ① Read these instructions
- ① Keep these Instructions
- ① Heed all warnings
- ① Follow all instructions
- ① Do not use this apparatus near water
- ① Clean only with a dry cloth
- ① Do not block any ventilation openings. Install in accordance with the manufacturer's instructions
- ① Do not install near any heat sources such as radiators, heat registers, stoves, or other apparatus (including amplifiers) that produce heat.
- ① Do not defeat the safety purpose of the polarized or grounding-type plug. A polarized plug has two blades with one wider than the other. A grounding type plug has two blades and a third grounding prong. The wide blade or third prong are provided for your safety. If the provided plug does not fit into your outlet, consult an electrician for replacement of the obsolete outlet.
- ① Protect the power cord from being walked on or pinched particularly at plugs, convenience receptacles, and the point where they exit from the apparatus.
- ① This unit must be connected to a mains socket outlet with a protective earth connection.
- ① The AC wall outlet should be installed near to the unit and be easily accessible.
- ① Only use attachments / accessories specified by the manufacturer
- ① Unplug this apparatus during lightning storms or when unused for long periods of time
- ① Refer all servicing to qualified servicing personnel. Servicing is required when the apparatus has been damaged in any way, such as power-supply cord or plug is damaged, liquid had been spilled or objects have fallen into the apparatus, the apparatus has been exposed to rain or moisture, does not operate normally, or has been dropped.



• **WARNING** To reduce the risk of fire or electric shock, do not expose this apparatus to rain or moisture.

C2-2375A SERIES OPERATION MANUAL

- ① The AC power cord or adaptor furnished with the unit should conform to the type in use in your country. Please compare the plug on your cord or adaptor with the power socket where the unit will be installed.

If you did not receive the correct plug, **DO NOT** attempt to modify it. Instead, immediately contact your dealer or contact TV One at the sales office nearest to your geographic location and request the proper plug.

2.1 Intellectual property

Some IC chips in this product include confidential and/or trade secret property. Therefore you may not copy, modify, adapt, translate, distribute, reverse engineer, reverse assemble or decompile the contents thereof.

2 CONSIGNE IMPORTANTE DE SECURITE

Pour obtenir les meilleures performances avec ce produit, nous vous demandons de lire soigneusement ce manuel.

- ① Lisez ces consignes
- ① Conservez ces consignes
- ① Respectez tous les avertissements
- ① Respectez toutes les consignes
- ① N'utilisez pas cet appareil à proximité d'eau
- ① Nettoyez-le en utilisant uniquement un chiffon sec
- ① Ne bloquez pas les ouvertures de ventilation. Installez cet appareil en respectant les consignes du constructeur
- ① Ne procédez pas à une installation à proximité de sources de chaleur, quelles qu'elles soient, (radiateurs, registres calorifiques, fours, etc.) ou d'autres appareils (dont des amplificateurs) qui produisent de la chaleur
- ① Ne cherchez pas à détourner l'objectif de la prise électrique à polarisation ou à mise à la masse. Une prise électrique polarisée comporte deux lames de largeurs différentes. Une prise à mise à la masse a deux lames et une broche de mise à la masse. La lame la plus large ou la troisième broche ont pour but de vous protéger. Si la prise fournie ne correspond pas à la prise murale, consultez un électricien pour remplacer l'élément obsolète
- ① Protégez le cordon électrique pour éviter que l'on ne marche dessus ou qu'on ne le coince, en particulier au niveau des prises mâles ou des prises murales et au niveau de l'appareil
- ① Il faut brancher l'appareil sur une prise du secteur disposant d'une mise à la terre.
- ① La prise murale de courant doit être installée près de l'unité et aisément accessible.
- ① Utilisez uniquement les fixations et accessoires spécifiés par le fabricant
- ① Débranchez cet appareil durant les orages électriques ou pendant les périodes prolongées d'inactivité
- ① Confiez toutes les interventions d'entretien à un personnel qualifié spécialisé dans l'entretien. Une intervention d'entretien s'avère nécessaire lorsque cet appareil a été endommagé, d'une façon ou d'une autre, par exemple lorsque le cordon d'alimentation électrique ou sa prise est endommagé, lorsqu'il y a eu un épanchement de

C2-2375A SERIES OPERATION MANUAL

liquide ou lorsque des objets sont tombés sur cet appareil, voire même lorsque cet appareil a été exposé à de la pluie ou une humidité, ne fonctionne pas normalement ou est tombé.



AVERTISSEMENT Pour réduire tout risque d'incendie ou de choc électrique, n'exposez pas cet appareil à la pluie ou à une humidité.

- ① Le câble d'alimentation secteur ou l'adaptateur remis avec cet appareil doit être conforme au type employé dans votre pays. Veuillez comparer la prise de votre cordon électrique ou de votre adaptateur à la prise murale de l'emplacement où doit être installé votre appareil.

Si vous n'avez pas reçu la bonne prise, **N'ESSAYEZ PAS** de la modifier. Vous devez au contraire immédiatement contacter votre revendeur ou le bureau de vente TV One le plus proche de chez vous pour demander la bonne prise.

2.1 Propriété intellectuelle

Certaines puces à circuits imprimés de ce produit contiennent des données confidentielles et (ou) des secrets professionnels. Par conséquent, vous ne pouvez pas recopier, modifier, adapter, traduire ou distribuer son contenu ou procéder à une ingénierie inverse ou à une décompilation de ce contenu.

2 WICHTIGE SICHERHEITSANWEISUNGEN

Lesen Sie diese Bedienungsanleitung sorgfältig, um zu gewährleisten, dass Sie den optimalen Nutzen aus diesem Produkt ziehen.

- ① Lesen Sie diese Anweisungen.
- ① Bewahren Sie diese Anweisungen auf.
- ① Beachten Sie alle Warnhinweise.
- ① Befolgen Sie alle Anweisungen.
- ① Verwenden Sie dieses Gerät nicht in der Nähe von Wasser.
- ① Verwenden Sie zur Reinigung nur ein trockenes Tuch.
- ① Blockieren Sie keine Lüftungsöffnungen. Installieren Sie das Gerät nach den Anweisungen des Herstellers.
- ① Stellen Sie das Gerät nicht in der Nähe von Wärmequellen wie etwa Heizkörpern, Heizklappen, Öfen oder anderen Wärme erzeugenden Geräten (einschließlich Verstärkern) auf.
- ① Setzen Sie den Sicherheitszweck von unvertauschbaren Steckern oder Erdungssteckern nicht außer Kraft. Ein unvertauschbarer Stecker besitzt zwei Messerkontakte, von denen einer breiter als der andere ist. Ein Erdungsstecker besitzt zwei Messerkontakte und einen dritten Erdungskontakt. Der breitere Messerkontakt oder der Erdungskontakt dient Ihrer Sicherheit. Falls der mitgelieferte Stecker nicht an eine Steckdose angeschlossen werden kann, beauftragen Sie einen Elektriker, die veraltete Steckdose auszutauschen.
- ① Schützen Sie das Netzkabel, so dass niemand auf das Netzkabel treten kann oder es insbesondere an Steckern, Steckdosen und an der Stelle, an der das Netzkabel aus dem Gerät geführt wird, nicht eingeklemmt werden kann.
- ① Verwenden Sie nur Zusatzgeräte/Zubehör, die/das der Hersteller angibt.
- ① Ziehen Sie den Netzstecker dieses Geräts bei Gewittern und auch dann ab, wenn es über einen längeren Zeitraum nicht betrieben wird.
- ① Lassen Sie Reparaturen nur von qualifiziertem Wartungspersonal durchführen. Reparaturen sind erforderlich, wenn das Gerät in irgendeiner Form beschädigt wurde, beispielsweise das Netzkabel oder der Stecker beschädigt wurde, Flüssigkeit auf dem Gerät verschüttet wurde oder Objekte in das Gerät gefallen sind, das Gerät Regen oder Feuchtigkeit ausgesetzt wurde, nicht normal arbeitet oder fallen gelassen wurde.



WARNUNG: Setzen Sie das Gerät weder Regen noch Feuchtigkeit aus, um die Gefahr eines Brandes oder elektrischen Schlags zu minimieren.

- ① Das mitgelieferte Netzkabel oder der mitgelieferte Adapter müssen dem in Ihrem Land verwendeten Typ entsprechen. Vergleichen Sie den Netzstecker oder Adapter mit der Netzsteckdose, an die das Gerät angeschlossen wird.

Falls Sie nicht den richtigen Stecker erhalten haben, versuchen Sie **NICHT**, ihn zu ändern. Setzen Sie sich stattdessen mit Ihrem Fachhändler oder der Verkaufsniederlassung von TV One in Verbindung, die sich am nächsten an Ihrem Wohnort befindet, und fordern Sie den richtigen Stecker an.

2.1 Geistiges Eigentum

Einige IC-Chips in diesem Produkt enthalten vertrauliche Informationen und/oder Geschäftsgeheimnisse. Aus diesem Grund dürfen Sie deren Inhalt nicht kopieren, ändern, anpassen, übersetzen, verteilen zurückentwickeln oder dekompileieren.

2 INSTRUCCIONES IMPORTANTES DE SEGURIDAD

Para garantizar el máximo rendimiento de este producto, lea cuidadosamente este manual.

- ① Lea estas instrucciones
- ① Guarde estas instrucciones
- ① Respete todas las advertencias
- ① Siga todas las instrucciones
- ① No use este aparato cerca del agua
- ① Límpielo sólo con un paño seco
- ① No bloquee ninguna abertura de ventilación. Instálelo de acuerdo con las instrucciones del fabricante
- ① No lo instale cerca de fuentes de calor como radiadores, salidas de aire caliente, estufas u otros aparatos (incluyendo amplificadores) que produzcan calor.
- ① Respete la finalidad de seguridad de las clavijas polarizadas o con toma de tierra. Una clavija polarizada tiene dos cuchillas, una más ancha que la otra. Una clavija del tipo de puesta a tierra tiene dos cuchillas y un tercer borne para puesta a tierra. La cuchilla más ancha o el tercer borne son para su seguridad. Si la clavija suministrada no se adapta a su toma de corriente, consulte a un electricista para que cambie la toma obsoleta.
- ① Proteja el cable de alimentación para que no se pueda pisar ni pellizcar, especialmente junto a las clavijas, tomas de corriente, y en el punto de salida de las mismas en el aparato.
- ① Use sólo accesorios / elementos especificados por el fabricante
- ① Desenchufe el aparato durante las tormentas eléctricas o si no va a usarlo durante un largo período de tiempo.
- ① Consulte con personal cualificado cualquier tipo de servicio. Se necesitará servicio cuando el aparato haya sufrido daños de cualquier tipo, como daños en el cable de alimentación o en las clavijas, haya entrado líquido o se hayan caído objetos dentro del aparato, haya estado expuesto a la lluvia o humedad, no funcione normalmente o se haya caído.



ADVERTENCIA: Para reducir el riesgo de incendio o electrocución, no exponga el aparato a la lluvia ni la humedad.

- ① El cable de alimentación de C.A o el adaptador suministrado con la unidad debe ser conforme al tipo usado en su país. Compare la clavija en su cable o adaptador con la toma de corriente donde vaya a instalar la unidad.

Si no ha recibido la clavija correcta, **NO** intente modificarla. Póngase inmediatamente en contacto con su distribuidor o con TV One en la oficina de ventas más cercana a su localización geográfica y solicite la clavija adecuada.

2.1 Propiedad intelectual

Algunos chips con circuitos integrados presentes en este producto incluyen propiedad confidencial y/o secreta del sector. Por lo tanto, usted no puede copiar, modificar, adaptar, traducir, distribuir, diseñar a la inversa, montar a la inversa o descompilar el contenido de los mismos.

2 BELANGRIJKE VEILIGHEIDSINSTRUCTIE

Om dit product optimaal te kunnen gebruiken, dient u deze handleiding aandacht te lezen.

- ① Lees deze instructies
 - ① Bewaar deze instructies
 - ① Let op alle waarschuwingen
 - ① Volg alle instructies
 - ① Gebruik dit apparaat niet in de nabijheid van water
 - ① Reinig het apparaat alleen met een droge doek
 - ① Blokkeer geen ventilatieopeningen. Installeer het apparaat volgens de instructies van de fabrikant
 - ① Plaats het apparaat niet in de nabijheid van warmtebronnen zoals radiatoren, kachels, warmtesensoren zoals thermometers, of andere apparaten (waaronder versterkers) die warmte afgeven.
 - ① Omzeil het beveiligingsoogmerk van de gepolariseerde of geaarde stekker niet. Een gepolariseerde stekker heeft twee pinnen, waarvan de een breder is dan de ander. Een geaarde stekker heeft twee pinnen, en een derde pin; een zogeheten aardlekpun. De bredere pin of aardlekpun is er voor uw veiligheid. Als de geleverde stekker niet in het stopcontact past, vraag dan een elektricien om het verouderde stopcontact te vervangen.
 - ① Bescherm de netspanningkabel zodanig dat er niet op kan worden gelopen en dat er geen kink in kan komen, vooral bij de stekker, pinnen, en bij de aansluiting op het apparaat
 - ① Gebruik alleen de accessoires en onderdelen die door de fabrikant worden aanbevolen
 - ① Haal de stekker van dit apparaat bij onweer uit het stopcontact. Doe dit ook wanneer het apparaat lange tijd niet wordt gebruikt.
 - ① Laat alle onderhoud over aan gekwalificeerd personeel. Onderhoud is vereist wanneer het apparaat op enigerlei wijze is beschadigd, bijvoorbeeld in het geval van een beschadigd netsnoer of een beschadigde stekker, wanneer er vloeistof op het apparaat is gemorst, of wanneer er een voorwerp in het apparaat is gevallen, wanneer het apparaat is blootgesteld aan regen of vocht, niet normaal functioneert, of is gevallen.
- !** WAARSCHUWING Om het risico op brand of een elektrische schok te verkleinen, dient u dit apparaat niet bloot te stellen aan regen of vocht.
- ① Het type wisselspanningkabel of adapter dat met deze eenheid is geleverd, dient overeen te komen met wat in uw land wordt gebruikt.

C2-2375A SERIES OPERATION MANUAL

Vergelijk de stekker van de kabel of adapter met het stopcontact waarop de eenheid wordt aangesloten.

Als u niet de juiste stekker hebt ontvangen, breng dan zelf **GEEN** wijzigingen aan. Neem in plaats daarvan direct contact op met uw dealer of met de afdeling verkoop van TV One die zich het dichtst bij u in de buurt bevindt en vraag om de juiste stekker.

2.1 Intellectueel eigendom

In bepaalde IC-chips in dit product zijn vertrouwelijke informatie en/of geheime handelseigendommen opgenomen. Het is u daarom niet toegestaan om de inhoud ervan te kopiëren, wijzigen, aanpassen, vertalen, verspreiden, te onderwerpen aan reverse engineering, reverse assembly, of te decompileren.

2 VIKTIGA SÄKERHETSANVISNINGAR

För att få ut det bästa av din produkt bör du läsa denna bruksanvisning noggrant.

- ❶ Läs dessa anvisningar
- ❶ Spara dessa anvisningar
- ❶ Rätta dig efter alla varningar
- ❶ Följ alla instruktioner
- ❶ Använd inte enheten nära vatten
- ❶ Rengör enheten endast med torr trasa
- ❶ Blockera inte ventilationsöppningarna. Installera enheten enligt tillverkarens anvisningar
- ❶ Placera inte enheten nära värmekällor, som värmeelement, varmluftsintag, spisar eller annan utrustning (inklusive förstärkare) som producerar värme.
- ❶ Försök inte använda en stickkontakt i ett uttag som den inte är utformad att användas i. En polariserad kontakt har två blad – det ena bredare än det andra. En jordad kontakt har två blad och ett tredje jordstift. Det breda bladet eller jordstiftet är till för din säkerhet. Om den medföljande stickkontakten inte passar i ditt eluttag måste du kontakta en elektriker för att få eluttaget utbytt.
- ❶ Skydda nätsladden så att man inte kan trampa på den eller klämma den, särskilt intill stickkontakten, vid grenuttag och där den kommer ut från enheten.
- ❶ Använd bara anslutningar och tillbehör som specificeras av tillverkaren.
- ❶ Dra ur nätsladden före åskväder eller när enheten inte ska användas en längre tid.
- ❶ Överlåt all service åt kvalificerad servicepersonal. Service krävs när enheten är skadad på något sätt, t.ex. om nätsladden eller stickkontakten har skadats, om vätska eller främmande föremål har kommit in i enheten, om enheten har utsatts för regn eller fukt, om den inte fungerar normalt eller om den har tappats i golvet.



VARNING Med tanke på risken för brand och elchock får enheten inte utsättas för regn eller fukt.

- ❶ Den medföljande nätsladden eller adaptorn måste vara av den typ som används i ditt land. Jämför stickkontakten på nätsladden eller adaptorn med eluttaget där enheten ska installeras.

Om du inte fick rätt stickkontakt **FÅR DU INTE** försöka anpassa den. Kontakta i stället omedelbart butiken eller TV Ones närmaste försäljningsställe och be att få rätt stickkontakt.

2.1 Intellektuell egendom

Vissa IC-chip i denna produkt innehåller konfidentiellt material och/eller företagshemligheter. Du får därför inte kopiera, modifiera, anpassa, översätta eller distribuera innehållet eller använda reverse engineering, assemblering eller dekompilering på det.

2 VIKTIGE SIKKERHETSANVISNINGER

For at du skal få mest mulig ut av dette produktet, ber vi deg lese denne håndboken nøye.

- ① Les disse anvisningene.
 - ① Ta vare på disse anvisningene.
 - ① Vær oppmerksom på alle anvisningene.
 - ① Følg alle anvisningene.
 - ① Ikke bruk dette apparatet i nærheten av vann.
 - ① Må bare rengjøres med en tørr klut.
 - ① Ikke blokker ventilasjonsåpningene. Må installeres i overensstemmelse med produsentens anvisninger.
 - ① Må ikke installeres i nærheten av varmekilder som radiatorer, varmeapparater, komfyrer eller andre apparater (også forsterkere) som produserer varme.
 - ① Ikke sett sikkerhetsinnretningen til det polariserte eller jordete støpselet ut av funksjon. Et polarisert støpsel har to pinner, hvor den ene er bredere enn den andre. Et jordet støpsel har to pinner pluss en tredje jordingspinne. Den brede pinnen eller tredje pinnen er der av hensyn til sikkerheten. Hvis støpselet som følger med ikke passer i kontakten, må du kontakte en elektriker for å få skiftet ut kontakten.
 - ① Beskytt ledningen mot å bli tråkket på eller klemt, spesielt ved støpselet, stikkkontakten og punktet hvor den kommer ut av apparatet.
 - ① Ikke bruk andre typer tilbehør enn det som er angitt av produsenten.
 - ① Koble apparatet fra strømforsyningen i tordenvær eller når det ikke skal brukes over en lengre periode.
 - ① Overlat all service til kvalifisert servicepersonell. Apparatet trenger service hvis det på en eller annen måte har fått en skade, for eksempel at ledningen eller støpselet er ødelagt, det er blitt sølt væske på eller gjenstander har falt inn i apparatet, apparatet har vært utsatt for regn eller fuktighet, ikke fungerer som det skal eller har falt i gulvet.
- !** **ADVARSEL** For å redusere faren for brann eller elektrisk støt, må apparatet ikke utsettes for regn eller fuktighet.
- ① Strømledningen (vekselstrøm) eller adapteren som følger med enheten må tilsvare den typen som brukes i landet der du bor. Sammenlign støpselet på ledningen eller adapteren med stikkkontakten der hvor enheten skal installeres.

C2-2375A SERIES OPERATION MANUAL

Hvis du har fått feil støpsel, må du **IKKE** forsøke å modifisere det. I stedet må du straks kontakte forhandleren eller nærmeste salgskontor for TV One og be om riktig type støpsel.

2.1 Opphavsrett

Noen av IC-brikkene i dette produktet inneholder fortrolig informasjon og/eller fabrikkhemmeligheter. Du må derfor ikke kopiere, endre, tilpasse, oversette, distribuere, rekonstruere kildekodene til eller dekompile noe av dette innholdet.

2 TÄRKEITÄ TURVALLISUUSOHJEITA

Lue tämä opaskirja huolellisesti, jotta saat parhaan hyödyn tästä tuotteesta.

- ① Lue nämä ohjeet
 - ① Säilytä nämä ohjeet
 - ① Ota kaikki varoitukset huomioon
 - ① Noudata kaikkia ohjeita
 - ① Älä käytä tätä laitetta veden lähellä
 - ① Puhdista vain kuivalla kankaalla
 - ① Älä tuki ilma-aukkoja. Asenna laite valmistajan ohjeiden mukaisesti.
 - ① Älä asenna laitetta lähelle lämpölähteitä, kuten esim. lämpöpatteria, lämmitintä, uunia tai muita lämpöä tuottavia laitteita (vahvistimet mukaan lukien).
 - ① Älä tee tyhjäksi polarisoidun tai maadoitetun pistokkeen turvallisuustarkoitusta. Polarisoitussa pistokkeessa on kaksi kosketuspiikkiä, joista toinen on leveämpi. Maadoitetussa pistokkeessa on kaksi kosketuspiikkiä ja kolmas maattokosketin. Leveä kosketuspiikki tai kolmas maattokosketin on turvallisuusominaisuus. Jos toimitettu pistoke ei sovi pistorasiaan, pyydä sähköasentajaa asentamaan uusi pistorasia.
 - ① Varmista, että verkkojohdon yli ei kävellä eikä se jää puristuksiin etenkin pistoke- ja liitinkohdista sekä laitteesta ulostulevista kohdista.
 - ① Käytä vain valmistajan määrittämiä lisälaitteita/lisävarusteita.
 - ① Kytke laite irti verkkovirrasta ukkosmyrskyn aikana tai silloin, kun sitä ei käytetä pitkään aikaan.
 - ① Jätä kaikki huoltotoimenpiteet pätevän huoltohenkilöstön suoritettavaksi. Laite on toimitettava huoltoon, jos se on vahingoittunut jotenkin, kuten esim. verkkojohto tai pistoke on vioittunut, laitteeseen on joutunut nestettä tai laitteen päälle on pudonnut esineitä, laite on altistunut sateelle tai kosteudelle, laite ei toimi normaalisti tai se on pudonnut.
- !** VAROITUS! Älä altista tätä laitetta sateelle tai kosteudelle tulipalon tai sähköiskun vaaran vähentämiseksi
- ① Laitteen mukana tulevan verkkojohdon tai sovittimen tulee olla yhdenmukainen maassa jo käytössä olevien kanssa. Tarkasta, että verkkojohdon pistoke tai sovitin sopii asennuspaikassa olevaan pistorasiaan.

Jos laitteen pistoke on väärä, **ÄLÄ** yritä muunnella sitä. Ota heti yhteys jälleenmyyjään tai lähimpään TV One -myyntikonttoriin ja pyydä oikeaa pistoketta.

2.1 Immateriaaliomaisuus

Jotkut tässä tuotteessa olevat IC-sirut sisältävät luottamuksellista ja/tai liikesalaisuusomaisuutta. Sen tähden sisältöä ei saa kopioida, muokata, kääntää, jakaa, takaisinmallintaa, mallintaa symbolisella konekielellä tai kääntää takaisin.

3 CAPABILITY, DEVICE FEATURES AND PRODUCT FEATURES

3.1 Device Capabilities

The C2-2375A uses the proprietary CORIO[®]2 Engine to perform its functions, being the second generation of the successful CORIO[®] products. The CORIO[®]2 technology is a powerful toolset for any application requiring high quality video signal conversion or image manipulation.

The unit features a single main video processing and scaling engine, with video mixing, keying and fader capabilities. A secondary scaler is provided to allow scaling of the output to another resolution or video format.

These functions allow the flexibility for handling a wide range of inputs and outputs, depending on the unit used.

Supporting DVI and HDMI resolutions up to 1920x1200@60Hz, 3G-SDI, Composite Video, YC (S-Video), YUV/YPbPr, and HDCP on DVI/HDMI inputs and outputs.

The DVI input and outputs on the unit provide the extra flexibility of DVI-U functionality, this provides the same connectivity as a DVI-I connection but with the additional provision of Composite and YC video.

3.2 Device Features

General Topography

4:4:4 RGB / YUV sampling provides full bandwidth color which allows precise keying where included in the unit's capabilities. This can be achieved through the transparent (soft) keys on the front of the unit. Each unit's video inputs accommodate multiple video and computer signal formats and resolutions – see specifications at end of manual for full details.

Ultimate flexibility

The C2-2375A output signal format flexibility assures that the Native Resolution of virtually any display can be matched. Because of the resolution calculator (included in the CORIOtools suite), even new resolutions can be added to the unit. Signal parameter adjustments can be made for each video input and are stored in individual non-volatile memories for retrieval once the unit's power has been removed. The Video Scaler units employ pixel adaptive motion compensation to de-interlace fast moving images, and automatic 3:2 Pull-down efficiently de-interlaces video from 24 fps NTSC film.

Simple Control

The unit can be controlled in various ways. One option is to control it from the front panel using the keys on the front of the unit. It can also be controlled via RS-232/422/485 or via Ethernet using the CORIOtools suite.

C2-2375A SERIES OPERATION MANUAL

The CORIOtools suite is available for download from our Internet site and affords complete control of the unit.

Upgradeability

The C2-2375A also benefits from firmware upgradeability, thus reducing product obsolescence by allowing the installation of the latest version of firmware. This not only applies to the software used to control the unit, but also to the range of resolutions stored inside the unit, the addition of new features, and upgrades to the heart of the image processing hardware – the CORIO[®]2 scaling engine. See <http://www.tvone.com/support> for more detail.

5 UNPACKING AND INSTALLATION

5.1 Shipping Carton

Your unit will arrive double boxed for maximum protection during shipping. You are encouraged to retain both boxes and all packing material so the unit can be returned in the unlikely event that repairs should ever become necessary.

5.2 Important Safety Instructions

The AC power cable furnished with the unit should conform to the type in use in your country. Please compare the plug on your cable with the power socket where the unit will be installed.

If you did not receive the correct cable, **DO NOT** attempt to modify it. Instead, immediately contact your dealer or contact TV One at the sales office nearest to your geographic location and request the proper cable.

Installation should be made such that the system fans are not touching other pieces of equipment, and such that they may not be accidentally touched by users.

5.3 Initial Operation Check Using Factory Default Settings

This product can be operated via multiple methods, but for the purposes of initially acquainting you with the operation of the unit, this manual will address the operation using the Front Panel controls.

If you have problems using the unit as described below, see the 'Factory reset' description shortly afterwards.

We'll be using a Personal Computer for a signal source and a PC monitor that can support 1024 x 768 @ 60Hz as this is the default output resolution.

Disconnect the cable going from a Personal Computer's Monitor to the Personal Computer. Connect the output from the PC video card (the PC connector formerly used by the monitor cable) to the input on the rear panel of the unit.

Next, take the cable from the PC monitor and connect it to the unit's output. Then connect the AC power cable to a working AC outlet, turn on the PC, monitor and then your unit.

Provided you have not changed anything from the Factory Defaults then your PC's image should appear on the display as normal.

6 FRONT PANEL CONTROLS

The range of buttons on the front of the unit provides the user with quick access for selecting a variety of inputs and features.

The cross-hair (up/down/left/right) buttons on the front panel provides the user with a way of navigating the Liquid Crystal Display menus (LCD) which is detailed in a later section.

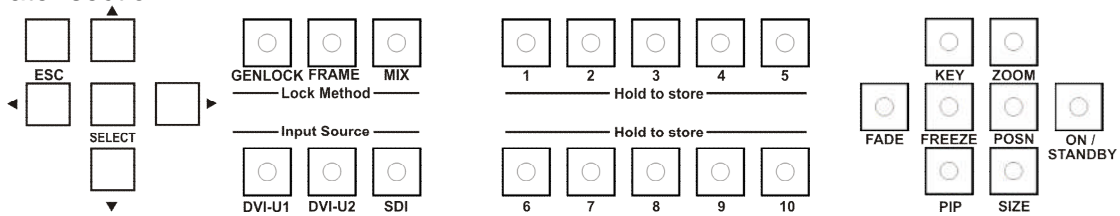

6.1 Button controls

A sub-set of the following buttons will be available on the front of the unit, depending on the model in use:

C2-2375A SERIES OPERATION MANUAL

Button	Button Function
Menu navigation & adjustment buttons.	Up / down / left / right / SELECT allow quick and easy access to various menu settings. Press and hold SELECT to store current settings into memory. They will then be restored on power-on, or when a Restore is done. See next section for more information.
DVI-U1	Selects DVI-U1 as the current source for conversion.
DVI-U2	Selects DVI-U2 as the current source for conversion.
SDI	Selects the SDI input as the current source for conversion.
Presets 1 to 10	Recalls a preset. These start off blank, but are available to the user.
GENLOCK	Sets Lock mode to Genlock. This locks the unit's output to the current Lock source (which defaults to the Ref input). See 'Adjust output 1' menu details.
FRAME	Sets Lock mode to Framelock. This locks the unit's output frame rate to the current Lock source. See 'Adjust output 1' menu details.
MIX	Sets Lock mode to Lock & Mix, to overlay onto the current Lock source. Use with the KEY and FADE buttons for more flexibility. A 2 nd press will swap foreground and background. See 'Adjust output 1' menu details.
KEY	Enables keying for currently selected window – see 'Adjust keyers' menu. (Key color defaults to black, so black foreground will disappear.)
ZOOM	Jumps to the 'Zoom' menu item.
FADE	Fades out the current image – fades back in on next press.
FREEZE	Freezes the currently selected window
POSN	Jumps to the Pan or Pos menu item to allow immediate panning or positioning of the image.
PIP	Activate picture-in-picture mode for the currently selected window.
SIZE	Jumps to the 'Shrink' menu item to allow the current window to be re-sized.
ON/STANDBY	Hold in to put the unit into Standby (power-save) mode. Press once to come out of Standby mode.

6.2 Special button combinations and functions

In addition to the ability to perform a factory reset and forcing certain output resolutions, other button combinations are available:

These button combinations only work when the unit is switched on and active i.e. with the STANDBY/ON LED is off. They will not work in Standby mode, or during power-up.

6.2.1 Saving current settings

Press and hold the SELECT button until a beep is heard and the unit shows 'Settings stored'.

6.2.2 Locking front panel buttons & IR remote control

This can be performed by pressing STANDBY/ON and FREEZE at the same time. All front panel buttons and IR remote control commands will be disabled, with the exception of repeating the above combination to un-lock the unit and for storing the current locked buttons setting (thus letting you make sure the unit always starts up with the buttons locked).

The STANDBY/ON button will flash when the unit's buttons are locked.

6.2.3 Restore power-on settings

This can be done (without having to turn off the unit) by pressing STANDBY/ON and the menu navigation SELECT button at the same time until a single beep is heard.

6.2.4 Factory Reset

If you wish to restore all operational parameters to their original condition (for example, if saved settings prevent the unit from working with your display monitor), hold the STANDBY/ON and the SELECT button in together until two beeps are heard.

All stored settings except resolutions are lost when the unit is reset. A Firmware update is the only way to perform a complete factory reset (including resolution data)

7 VIDEO INPUTS AND OUTPUTS

The diagrams below show the left and right-hand halves of the rear panel.

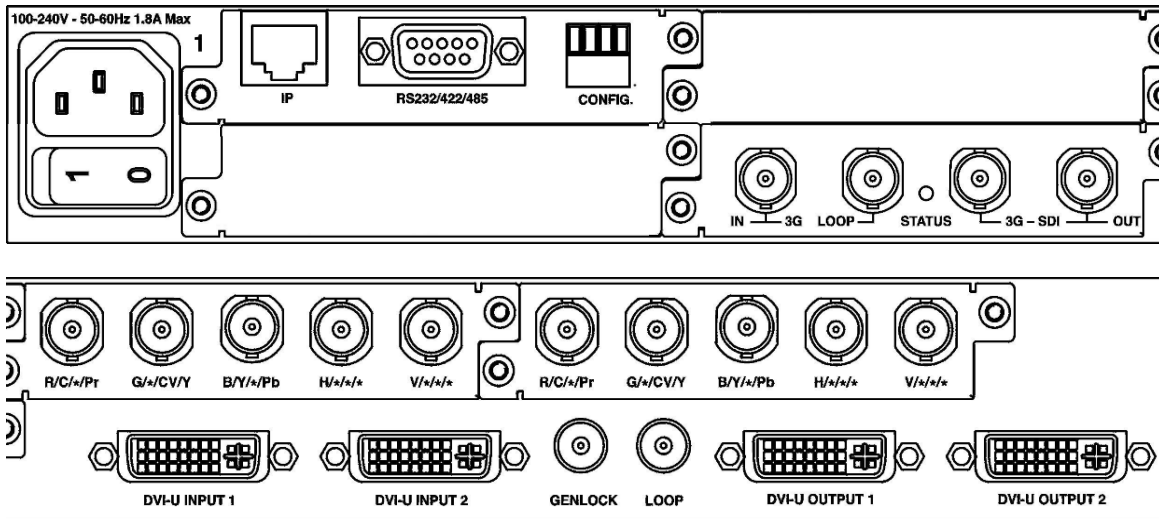

7.1 Computer & Video inputs

The DVI-U inputs can accept:

- Digital DVI-D or HDMI signals
- Analog Composite Video
- Analog Y/C (S-Video)
- Analog RGBHV (separate syncs at TTL levels)
- Analog RGsB (sync on green)
- Analog RGBS (separate sync at TTL levels)
- Analog YUV/YPbPr (including tri-level)

For DVI-D, RGBHV, RGBS, RGsB and CV the particular input being used will be auto-detected.

For all signals except DVI-D, an adaptor cable is required for use. See 'Connector pin-outs' for more information.

Alternatively, the DVI-U input 2 is replicated using the BNCs above – where and analog source can be fed in. (This has to be manually selected using the 'Input type' selection in 'Adjust sources'.)

CV and YC sources can be either standard NTSC or PAL inputs – for example, from a video camera, VCR, DVD player, gaming device, etc. PAL and NTSC detection is automatic.

The DVI-D input accepts DVI digital connections (but on a DVI-I socket for added flexibility). An EDID signal is used to ensure that the PC or DVD player outputting the DVI signal knows the available range of resolutions in the unit.

To enable an input for HDMI usage, set the 'EDID to use' to [HDMI] in 'Adjust sources'. Once active, the DVI-U input will also accept audio via the HDMI link.

The table below shows how to select a particular input using the 'Adjust source' / 'Input type' menu:

Source	Connection	Input type setting
DVI-D	DVI-U	Auto / D-RGB
HDMI*	DVI-U	Auto / D-RGB / D-YUV
RGBHV / RGBS / RGsB	DVI-U	Auto / A-RGB
YPbPr / YUV	DVI-U	Auto / A-YUV
CV	DVI-U on 'Green'	Auto / A-CV
Y/C	DVI-U on 'Blue'/'Red'	A-YC
RGBHV / RGBS / RGsB	BNC panel	B-RGB
YPbPr / YUV	BNC panel	B-YUV
CV	BNC 'Green'	B-CV
Y/C	BNC 'Blue'/'Red'	B-YC

*For HDMI, also set 'EDID to use' in 'Adjust sources' to [HDMI]

7.2 Computer & Video outputs

The DVI-U outputs can be:

- Digital DVI-D or HDMI signals
- Analog Composite Video
- Analog Y/C (S-Video)
- Analog RGBHV (separate syncs at TTL levels)
- Analog RGsB (sync on green)
- Analog RGBS (separate sync at TTL levels)
- Analog YUV/YPbPr (including tri-level)

When the output resolution (as set in 'Output res') is set to PAL or NTSC, then the DVI-U connectors will output the Composite Video and Y/C signals. For all other resolutions, the output type is set in the corresponding 'Adjust output' menu.

The analog outputs are replicated for Output 2 on the BNC connectors above it.

HDMI output is automatically enabled based on the display connected to the unit.

7.3 SDI inputs and outputs

All SDI connections are SD/HD/3G compliant.

The input will auto-detect the particular standard in use. The LOOP output will then output a copy of that signal (re-clocked).

The SDI output is active whenever the 'Output res' in 'Adjust output 1' is set to an SD/HD or 3G-SDI compatible resolution. Typically these are PAL, NTSC, 720p, 1080i and 1080p resolutions.

Both SDI outputs are identical, and follow whatever Output 1 (e.g. DVI-U output 1) is showing.

7.4 GENLOCK input

The Genlock input supports Composite Video (PAL or NTSC), along with tri-level HD signals (i.e. 480p, 720p, 1080i and 1080p).

You can enable locking to this reference source using the LOCK button on the front of the unit. The LOOP output is a buffered copy of the GENLOCK input, and remains active when the system is in Standby mode.

7.5 Audio

The standard unit does not support any audio I/O connectors, but any audio embedded into an HDMI or SDI source can be routed to any output. This is done in the 'Adjust outputs' menu.

7.6 System block diagram

The following block diagram should help to explain the way that the unit works internally.

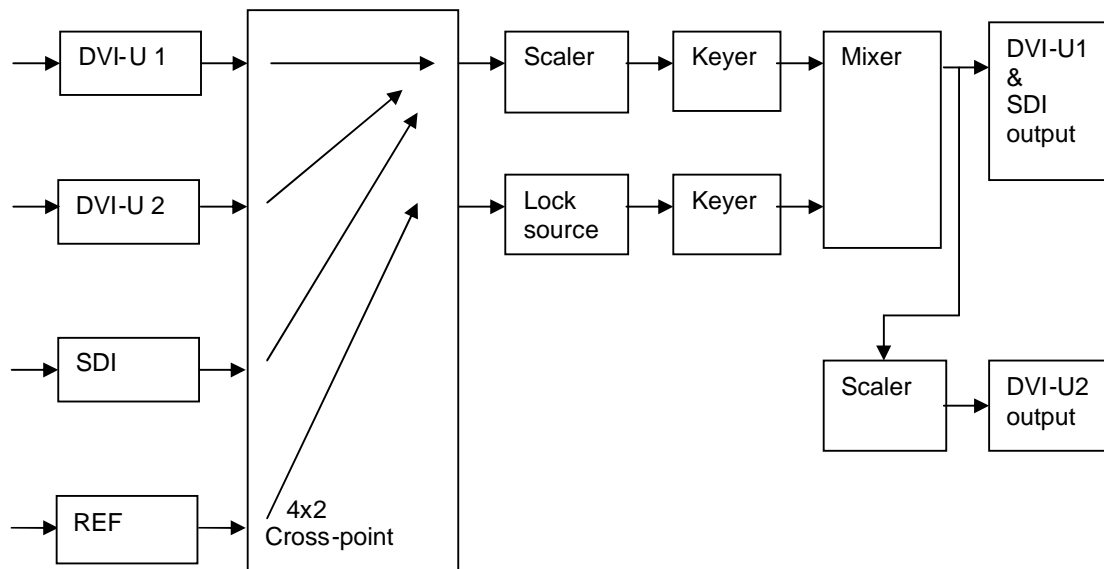

8 MENU LAYOUT AND SETTINGS ADJUSTMENT

From here on, we'll be looking at the menu structure employed in the C2-22375A and, more importantly, the individual menu items that allow you to take advantage of the power of the unit.

You'll be using the menu navigation buttons and the Liquid Crystal Display (LCD) to view the options and settings available to you. First press the left / right buttons to see where you are in the menu. Go into a sub menu by pressing the SELECT button once. To exit a sub-menu, scroll to the end of the sub-menu by pressing the right buttons to reveal Exit. Press SELECT to exit the sub menu.

You can also gain fast access to the start and end of a menu by clicking the up or down buttons.

You can edit a value in brackets '[]' by pressing the SELECT button once (you'll note that the brackets surrounding a particular parameter's value will begin to flash). Change the value by pressing left or right. Then finalize your adjustment by pressing the SELECT button once more.

A few menu items have multiple parameters within an individual menu selection. In those cases, you can adjust one item at a time. To do this, move to the next parameter by moving the multi-directional button left or right.

Adjust windows H/V zoom pan % [10] 20

Or, you can use the up / down buttons to alter the value following the one in brackets. Therefore, in the example above, where "[10] 20" is displayed in a menu item, the one in brackets is adjusted using the left and right buttons, and the second number be can be altered using the up and down buttons.

Holding the left, right, up or down buttons for a short time will keep adjusting the relevant value, therefore allowing fast changes to a setting – which is very useful for positioning something on screen.



Holding the SELECT button in for a few seconds stores all changes in memory. Unless you intentionally change it again later, the adjustment will remain even after power is removed from the unit.

Menus are arranged so that a particular general function has a menu name on the top line and beneath that either a sub-menu or one or more related individual settings are displayed.

In some cases the functionality is global – meaning it has an effect on the unit as a whole (such as changing the output resolution). In the majority of cases, the

C2-2375A SERIES OPERATION MANUAL

function is related to a specific operational area of the unit, detailed by the text in the top line.

There are two screens that appear before the Group Menus (sub-menus) are accessed.

TV One
C2-2375A

The first is the 'welcome' display shown above indicating the model of the unit.

www.tvone.com
SW: 350. PT: 12, BT: 13

Moving to the next menu item displays the firmware information screen (the numbers on your unit will be different to those shown). The SW number refers to the version of firmware loaded into the unit, this can be upgraded from the support website.

The PT and BT numbers refer to Hardware version information and are of interest to the Technical Support Group should you ever need assistance.

At the end of all Group Menus will be an 'Exit' item. Simply select this to exit the existing menu structure and return to the previous one in the hierarchy.

8.1 Group Names and Descriptions

Menu Group Name	Group Description
Presets	Loads, Stores and Erases Presets
Adjust output 1	Controls output 1 parameters
Adjust output 2	Controls output 2 parameters
Adjust windows	Controls characteristics of the pip windows
Adjust keys	Controls the keying ability of the unit
Adjust sources	Controls signal source input parameters
Adjust transitions	Controls the method of transition when switching video inputs
Adjust ethernet	Controls IP addresses and network parameters
Adjust resolutions	Controls unit's input/output resolution table
System	Controls global system parameters for the unit

Please note:

1. That the 'Advanced menus' menu item must be 'On' to activate certain menu items.

2. This unit has two outputs which have been split into two menus 'Adjust output 1' and 'Adjust output 2'. The manual details both of these menus in the single section 'Adjust outputs'.

8.2 Adjust presets menu item

Presets allow you to store up to 10 different setups of window size, position and keying controls. These are non-volatile and can be instantly recalled at a later time. They are only erased during a firmware update of the unit.

Presets only store and recall values in the Adjust outputs, Adjust windows, Adjust keyers, Adjust borders and Adjust logos menus (where your unit supports these). To store values present in the 'Adjust sources' menu, use the 'Push to Store' menu item found in 'Adjust system' or the special buttons on your unit..

Adjust preset [1] Load Store Erase

Once you have set your unit up in the way you want it to be, simply select the Preset number you want to store the setup detail into, and select the 'Store' item.

At a later time, you can then recall the whole setup by again selecting the correct Preset number and clicking on the 'Load' item.

The 'Erase' item only erases the select Preset number – all other Presets are unaffected. Erasing a Preset returns all those settings to Factory Defaults.

Some units will have dedicated PRESET buttons, in which case:

1. Press and release to Load the Preset
2. Press and hold to Store the current settings to the Preset
3. Press and hold for much longer to Erase the Preset.

8.3 Items Associated with the Adjust outputs group

This menu group allows adjustments to be made that specifically affect the output of the unit, including output resolution and locking/overlaying onto a computer or video source.

800 x 600 60Hz Lock mode [Off] [RGB1]
--

This menu item allows the lock mode to be selected and the lock source to be defined. The top line of the display shows the current detected resolution of the

C2-2375A SERIES OPERATION MANUAL

selected lock source (RGB1 in this example). The lock mode can be either Off, Genlock or Lock & Mix, with the operation of these shown in the following table:

Lock mode	Description
Off	The output resolution of the Output is defined by the setting for Output Resolution and there will be no background source visible.
Genlock	The output video will be "Genlocked" to the selected lock source. The output signal will be synchronous to the input sync and adjustable but there will still be no lock source visible.
Lock & Mix	The output video will be locked to the selected source, the syncs will be locked (but with an additional internal video processing delay) and the background for the output will be that of the Lock source (unless foreground and background are swapped).
Frm.lock*	The frame rate of the output will be locked to the frame rate of the input. This can only work if the output resolution frame rate matches that of the lock source frame rate. 'Frm.lock' will flash until a highly stable lock has been achieved.

**Only certain models support this.*

In both Genlock and Lock & Mix modes the source selected for the lock input determines the resolution of the Output image. The output resolution for the entire image can be no different than the resolution of the lock source. All synchronization signals are re-generated within the unit so they may look slightly different when compared on an oscilloscope to the original source.

In Frame-lock mode, the output resolution is independent of the lock source, but the frame-rate must match that of the source (e.g. 1280x1024 60Hz can be frame-locked to 640x480 60Hz). Frame-lock is very useful for synchronizing a HD-SDI output (e.g. 1080i 59.94Hz) to a composite video source (e.g. NTSC), or for scaling one resolution to another while avoiding any potential frame-rate conversion artifacts.

'H/V shift' can be used to align the output to the input more accurately, but this may cause instability until the lock is re-acquired ('Frm.lock' will flash).

Before turning the Lock feature on, you first must select a valid Lock source. Some units may not have all Lock sources available, depending on hardware limitations – see Specifications for details of limitations on your unit.

If the Lock source you choose is not valid, then Genlock or Lock & Mix will be temporarily disabled, until the Lock source becomes valid again. When disabled, the resolution previously specified in 'Output res' becomes the output resolution.

1024 x 768 60Hz Output res. [28]

Your unit can handle a very wide array of inputs and convert them all to a single output signal with defined characteristics. This output resolution will remain in place until changed or it may be overridden by the lock mode and source.

The top line of the display will show the current output resolution selected. Some units will have a limited number of output resolutions depending on their function (e.g. Down Converters are more limited than Video Scalers).

1024 x 768 60Hz HDCP (Active) On

HDCP is handled only on certain units with DVI outputs, so this menu may not appear on your own unit. HDCP is a 'High-bandwidth Digital Content Protection' system, which can ensure that a high definition video signal cannot be received by units not equipped with a HDCP receiver.

This menu lets you see the current status of the output and whether HDCP is supported or active, and also lets you turn off the output's HDCP encryption system. Note, however, that turning HDCP off at the output will also prevent HDCP-encrypted signals from being received by the unit – see the table below.

By default, HDCP on the output is turned On - so that if your attached DVI display is HDCP-compliant, then your output will be encrypted (regardless of whether the input to the scaler is encrypted). Note that you don't have to attach a display to the output of the scaler – another unit can be connected instead, in which case that unit is known as a 'repeater'.

Please also see the HDCP menu item in 'Adjust sources', as this controls availability of HDCP at the DVI input. The status message given in brackets has the following meaning:

C2-2375A SERIES OPERATION MANUAL

Status message	Description	Effect
No display	There is no display attached (HOTPLUG is low).	Nothing will be output on the DVI connector.
Unavailable	The device attached is not capable of supporting HDCP.	As the DVI output cannot be HDCP encrypted, then a HDCP-encrypted source cannot be selected for scaling.
Supported	The device attached is capable of HDCP, but the output is not currently encrypted.	As the DVI output is not HDCP encrypted, then a HDCP-encrypted source cannot be selected for scaling.
Active	The device attached is capable of HDCP, and the output from the unit is encrypted.	As the DVI output is HDCP encrypted, then a HDCP-encrypted source can be selected for scaling. Note that no other output connector (SDI, CV, YC, YUV or RGBHV) will function – since they are not encrypted.
Rep. supprt	The repeater unit (e.g. scaler) attached is capable of HDCP, but the output is not currently encrypted.	As the DVI output is not HDCP encrypted, then a HDCP-encrypted source cannot be selected for scaling.
Rep. active	The repeater unit (e.g. scaler) attached is capable of HDCP, and the output from the unit is encrypted.	As the DVI output is HDCP encrypted, then a HDCP-encrypted source can be selected for scaling. Note that no other output connector (SDI, CV, YC, YUV or RGBHV) will function – since they are not encrypted.

Adjust outputs Output type [RGBHV]
Adjust outputs Anlog= [RGBHV] Dig= RGBHV

This menu may appear as either of the above – depending on whether the analog and digital outputs are controlled separately.

This menu item allows you to select the type of signal output your unit will provide. Types of output vary depending on the resolution selected and include various types of component signals YUV or tYUV (tri-level YUV) and the full range of RGB type signals RGBHV, RGBS and RGsB (Sync on green).

Note that this value is remembered for each resolution – so you can set 1024x768 60Hz to RGBHV and 1280x720 60Hz to tYUV and both will be remembered separately. This value is not affected by a Factory reset – but is reset by a firmware update.

Adjust outputs Optimize for SDI [On]
--

This menu item is only available on certain units with an SDI output and when locking to a CV or YC input. An internal de-jitter circuit ensures that the SDI output has a low jitter over the full 10Hz to 100kHz range, even though the CV or YC input may have a high jitter. However, this is not always compatible with a CV/YC output where the colour sub-carrier should not be de-jittered and needs to follow a Lock

source's input – hence it should be turned Off if the CV/YC outputs are going to be used.

Adjust outputs
Stand. [NTSC-M/PAL-BDGI]

This menu item is only available when the Output resolution is set to PAL or NTSC. With this you can change the output type to the PAL or NTSC standard with the further option of changing the output to the additional PAL & NTSC standards such as PAL-M or PAL-N. SECAM is also available as an output on some units, provided the 'Output res' is set to PAL / 50Hz.

Adjust outputs
Luma/chr BW [Med] / [Med]

This menu item is only available on certain units when the Output resolution is set to PAL or NTSC. With this you can change the output filtering system to increase or decrease the image sharpness. In general, high sharpness can result in increased colour disturbance.

Adjust outputs
Back Y/U/V [16] [128] [128]

Sets the value of the fixed background color, which is present when PIP is used with no Lock source background displayed. This menu item is only available for units with overlay, keying and fading abilities.

Adjust outputs
Audio emb. [On] [DVI-U1]

For certain units with HDMI and/or SDI-compatible inputs and outputs, the audio can be de-embedded from the video signal and sent to a compatible output.

'On' enables this to happen, and allows the audio source to be selected. 'WinA' sets the audio source to follow that of the main window's video source.

8.4 Items Associated with the Adjust windows group

This menu group allows adjustment to be made to window specific parameters such as the window source, its position, size and zoom level.

Window size adjustment can be performed in a number of different ways according to whether 'Aspect adjust' is set to Simple, Advanced or Pixel. The main part of this text assumes Simple mode – see later for a detailed description of the other modes.

Adjust windows Window to adjust	[A]
------------------------------------	-----

This menu item only appears on units with multiple windows or PIPs. It is used to select which one you want to modify. Alternatively, use one of the dedicated buttons on the front panel to choose the window to adjust.

NTSC / 60Hz Source	[YC1]
-----------------------	--------

The source display screen allows the input source for the currently selected window to be changed. The top line of the display shows the detected characteristics of the signal. Valid Input sources match those available on the front of the unit.

Certain units do not have full flexibility of Window source and Lock source when Genlock or Lock & Mix are active (in the Adjust outputs menu group). See the Specifications for your unit to see if any limitations are present.

Adjust windows Window enable	[On]
---------------------------------	-------

Available on certain units only, this quickly enables or disables the window being adjusted.

Adjust windows Zoom level %	[100]
--------------------------------	--------

Changing this option, sets the amount of picture magnification you wish to use for the window Source. You are provided with the options to zoom the image from 100% to 1000% (10x zoom).

Adjust windows H/V zoom pan %	[50] [50]
----------------------------------	-------------

Once an image has been 'zoomed', this control allows the image to be positioned within the window so that any portion can be seen, not just the middle.

Adjust windows Image freeze	[Off]
--------------------------------	-------

This menu item allows the image to be frozen or unfrozen – thus keeping a single image on screen indefinitely. Note that images are not stored when power is removed from the unit.

Adjust windows H/V crop %	[0] 0
------------------------------	--------

This allows the scaled image to be cropped at the top/bottom edges, or at the sides. Typically, this is used when performing a picture-in-picture (PIP) function (only

C2-2375A SERIES OPERATION MANUAL

available on certain models), where the incoming video signal has a letterbox or pillarbox size (i.e. it has black areas at the top/bottom or sides).

By adjusting the H/V values, you can crop out the black areas to correct the size on the final output screen. Note that it does not change the shape or aspect ratio of the image – but just removes the parts of the image that are not required.

Adjust windows H/V out shift	[0] [0]
---------------------------------	-----------

This positions the selected Window horizontally and vertically on the monitor. This should only be used for 'fine tuning' and should not normally require adjustment – use the Shrink H/V adjustment when your image is less than 100% Shrink value.

Adjust windows Shrink level%	[50] [On]
---------------------------------	------------

Shrink Level determines the percentage of the monitor's total available screen space that the selected Window image occupies. Adjustment is provided for a reduction down to 10% of the overall output size. In most cases, this feature is used for picture-in-picture (PIP) when a background image is being used (for units with overlay abilities).

Note that some units do not have the [On] entry – this is only for units with a PIP button on the front, with turns this entry On and Off. On these units, this feature is 'Off' by default, so that the full image size of 100% is used. Shrink level will need to be turned On before any change to this value has an effect.

Adjust windows H/V position %	[100] [50]
----------------------------------	-------------

This menu option determines the position of the shrunken image on the monitor screen. This will move an image that is less than the full screen size left/right or up/down within the monitor's available screen space. It will not let you move the image off the screen, so certain values will appear to have no effect (unless you use a very low Shrink value like 10%).

Adjust windows Aspect change	[Normal]
---------------------------------	----------

This item provides a simple way of changing the output screen aspect ratio, to suit the incoming video signal and final output display size. Use the zoom/shrink functions for occasions when the aspect ratio is an odd format.

Adjust windows Aspect adjust	[Simple]
---------------------------------	----------

See later section for further details on this item.

Adjust windows Temporal interp.	[Off]
------------------------------------	-------

This is a feature only present in advanced units only. It greatly improves the method of frame-rate conversion, by allowing the unit to merge frames together during the process.

When 'Off', the unit will use frame-repetition when converting 50Hz to 60Hz (i.e. it has to duplicate every 5th frame), or frame-dropping when converting 60Hz to 50Hz (i.e. it has to drop every 6th frame). When 'On', smooth blending is applied so that frames are not lost, but blended together at the appropriate times.

Adjust windows Flicker Reduction	[Low]
-------------------------------------	-------

The Flicker Reduction menu item will only appear if you have selected a low resolution interlaced output such as PAL or NTSC. If you are using CV or YC outputs, this adjustment may be of interest, particularly when you have line drawings or similar fine detail. You can choose from four possible Flicker Reduction settings. You should use as little Flicker Reduction as possible because the Vertical detail will be softened at the highest setting.

Flicker mode	Function
Off	Disables flicker reduction (sharpest mode).
Low	Suitable for most input sources.
Med.	Enough for most situations such as thin line drawings
High	Highest amount of flicker reduction. Will cause loss of vertical detail in some images.

Adjust windows Image smoothing	[Auto]
-----------------------------------	--------

Image smoothing reduces the jagged-edges sometimes seen within an output image by softening it. It typically improves the quality of a scaled image greatly. There are four possible settings for this adjustment: "Off", "Med.", "High", and "Auto". The "Auto" setting is generally thought to be most desirable and will vary the smoothing process according to the amount of zoom taking place.

Adjust windows Image flip	[Off]
------------------------------	-------

Occasionally, it's necessary to cause the output image to be flipped Vertically, Horizontally or both – most commonly when a video projector is ceiling-mounted, or for special effects.

Adjust windows Show source label	[On]
-------------------------------------	------

Units that support source labeling have this menu item available, which allows the label to be turned on or off on a window-by-window basis.

Adjust windows	
Audio bars	[4]

Certain units can display audio bar measurements and this menu item displays how many stereo-bars are shown. A maximum of 4 stereo bars (8 bars in total, with left-right pairs next to each other) can be shown. Audio channels are always numbered from left to right, balanced to display bars on both sides of the each. A setting of 0 disables the audio bars from being shown.

Adjust windows	
Max fade level %	[100]

This Menu item fades the selected layer, and is only available on models with overlay abilities. Adjustment range is from solid to fully transparent.

Note: This menu item only appears on multi-channel scalars:

Adjust Windows	
Layer priority abABZ	[3]

This adjustment selects the order of the window layers. Layers are shown for 'a' and 'b' logo screens, Window 'A', Window 'B' and 'Z' is the Lock Source. The default condition is shown. The number shown is the current layer of the active window, when you adjust the layer number the layer stack indicator 'abABZ' will change to allow visualization of the layer stack. Note that layer 6 the Background Color is not shown as its layer position can not be altered – it will always be the background.

8.4.1 Extended scaling controls

The 'Aspect adjust' parameter is used to change the way that scaling of windows is controlled. By default it is set to 'Simple' which allows basic control of the window zoom and shrink sizes and positions – enough for simple tasks.

In 'Advanced' mode, it allows the horizontal (H) and vertical (V) components of the Zoom and Shrink functions to be adjusted independently, thus allowing custom aspect ratios to be created, or to convert from one aspect ratio to another.

In 'Pixel' mode, the user has direct access to pixel and line-accurate scaling functions. This lets the user specify the exact co-ordinates and size of the source image (within the video source), and the position and size of where this is placed in the output video signal.

The table below summarizes the different menu items in the different modes – the 'Simple' items have already been described earlier in this section, so only the 'Advanced' and 'Pixel' ones that are different (highlighted in bold) will be detailed here.

Simple	Advanced	Pixel
Zoom level % [100]	Zoom H/V [100]100 1.333:1	In [0],0 640,480
H/V zoom pan% [50] 50	H/V zoom pan% [50] 50	Out [0],0 640,480
H/V crop % [0] 0	H/V crop % [0] 0	
Shrink level % [50] Off	ShrnkH/V [50] 50 1.333:1	
H/V position % [50] 50	H/V position % [50] 50	

8.4.2 'Aspect adjust' = 'Advanced'

Adjust windows H/V zoom % [100] [100]1.333:1

This item allows the independent setting of the horizontal and vertical zoom values. The third number (1.333 in the example) is the Aspect Ratio resulting from the adjustments, which is automatically calculated for you based on the incoming resolution and the H & V Zoom values.

Most resolutions are 4:3 ratio, thus the third number will be 1.333 (4 divided by 3). Another common aspect ratio is 16:9 (16 divided by 9 = 1.777). PAL and NTSC inputs are physically 4:3 on your video monitor, but their actual pixel/line ratios are different and so will not display as 1.333.

Adjust windows Shrink H/V % [100] [100] 1.333
--

This item allows the setting of different Horizontal and Vertical 'shrink' sizes. The third number (1.333 in the example) is the Aspect Ratio resulting from the adjustments, which is automatically calculated for you based on the output resolution (the actual pixels & lines, not your physical screen size) and the H & V Shrink values.

Most resolutions are 4:3 ratio, thus the third number will be 1.333 (4 divided by 3). Another common aspect ratio is 16:9 (16 divided by 9 = 1.777). Therefore, to convert your 4:3 output into a 16:9 output, reduce the vertical (V) Shrink value to 75% and this will simulate a 16:9 output. PAL and NTSC inputs are physically 4:3 on your video monitor, but their actual pixel/line ratios are different and so will not display as 1.333.

8.4.3 'Aspect adjust' = 'Pixel'

Adjust windows In [300] , 150 750, 400
Adjust windows Out [50] , 50 250, 300

These menu items work together to specify the exact co-ordinates and size of the source image (within the video source) and the position and size of where this is placed in the output video signal – in other words the ‘In’ and ‘Out’ positions and sizes.

The diagram below should help to clarify the function of these values:

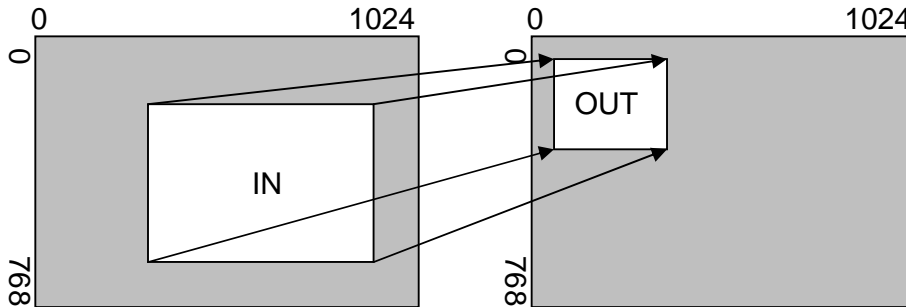

In the example above, ‘In’ has been set to 300,150 as its top-left source co-ordinate, with a size of 750,400. ‘Out’ has been set to 50,50 (i.e. close to the top left) with a size of 250,300.

The scaler will then ensure that the whole of the source (of size 750 by 400) is scaled to the required output (of size 250 x 300).

8.5 Items Associated with the Adjust keyers group

Please note that not all units have this sub-menu – it is only present on units with overlaying abilities.

Towards the end of this manual you will find a section titled ‘COMMON OPERATIONS’ – this gives a step-by-step guide to keying out a particular color.

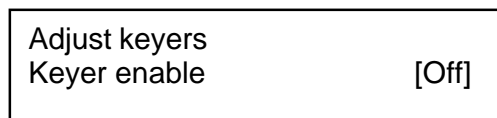

This menu item turns keying On or Off for the current foreground. A keyed image is in essence one image superimposed over another – such that portions of the top image are made transparent (keyed out), so that the background image can show through. The following settings allow you to vary the colour(s) that are keyed out.

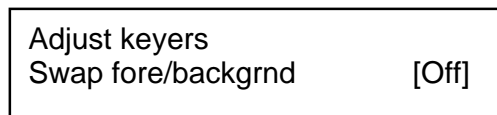

This menu item is only present on single-channel scalers – dual and quad-channel scalers have the layer priority set within the ‘Adjust Windows’ menu.

C2-2375A SERIES OPERATION MANUAL

This menu item allows you to swap the foreground and background images when Lock mode is set to Lock & Mix. It will have no effect in any other mode (since no background is present).

Normally, your foreground is the input (window) source and your background is the lock source. This then allows you to superimpose any graphics or video input on top of the lock source by keying out a certain color or range of colors in the input source. Swapping them means that the input source moves to the background and the lock source is now in front of it. Thus you are now keying out the lock source colors to reveal the input source behind it.

Note that this is different to simply swapping over the input and lock sources as that would affect the final output resolution – see examples below:

Input source	Lock source	Swap	Foreground (keyed)	Background (non-keyed)	Output resolution
XGA	NTSC	Off	XGA	NTSC	NTSC
XGA	NTSC	On	NTSC	XGA	NTSC
NTSC	XGA	Off	NTSC	XGA	XGA
NTSC	XGA	On	XGA	NTSC	XGA

(XGA is 1024x768)

You will see that the Swap between foreground and background has no effect on the output resolution as this is always set by the Lock source.

Adjust keyers Y Key min/max [0] [32]
--

The Min/Max parameters are used to select what range of Y (luminance/grey-scale) values are made transparent within the selected window/lock source. In order to key out part of an image, start with the max value and increase it until the required lighter parts within the window/lock source disappear. Then adjust the min level to bring back any darker parts of the image.

Adjust keyers Y Key softness [0]

The Y Key softness option removes noise from the keyed image, generally at the edges. Adjust as required to make the edges of the key as sharp or as soft as desired. The noise is where the analog to digital process (A/D conversion) may not sample a 50% brightness as being exactly 50% i.e. sometimes 49% and sometimes 51%. Increasing the softness value will broaden the range of keyed colors so that the keying of images varies depending on how close a color is to the keyed-out range.

Adjust keyers Y Key invert [Off]
--

The Y Key invert changes the keying characteristics with respect to what colors of the foreground image you wish to 'key out'.

Setting it to Off will cause the colour range that's defined to be removed - remove the desired colors. Setting it to On will cause the colour range that's defined to be kept - key out all other colors.

The descriptions above behave identically on the remaining U Key Invert & V Key Invert component versions. However they are directed at the U/B-Y (blue) colour component and V/R-Y (red) colour components respectively. Adjustment and effects are the same as explained above for Y Key Invert (brightness/grey-scale).

8.6 Items Associated with the Adjust sources group

The 'Adjust Sources' menu group accesses the parameters associated with the processing amplifiers used for each input (RGB, CV, YC, etc.). They allow you to fine-tune an incoming signal to optimize its color, brightness or even sharpness.

Not all settings are available for all input types, and not all input types listed here may be available on your unit. Also note that many of these adjustments may not show without 'Advanced menus' set to On.

It is recommended that you Store your settings once you're happy with them in readiness for future use.

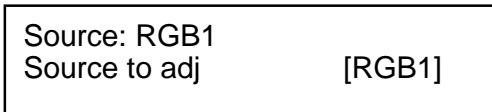

This menu item selects the input connection for which you want to make adjustments to. As in the image above, changes will only be made to the source connected to RGB1. Once the selection has been made, all changes made using the following operating parameters will only apply to the selected input.

Selection of a CV/YC source will reveal different menu items that allow adjustments beyond those used for RGB sources. The menu discussions that follow relate first to RGB sources, then to CV / YC type sources.

8.6.1 Menu items common to all inputs

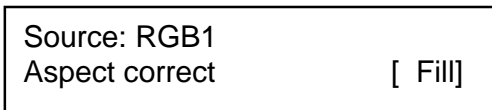

This menu item will be used to correct the aspect ratio of the video source when converted into the final output resolution. The following table details what happens in the available modes:

C2-2375A SERIES OPERATION MANUAL

Setting	Result
Fill (default)	The source is stretched to fill the output.
Aspect	The source's aspect ratio is maintained on the output.
H-fit	The source is stretched to fill the horizontal dimension of the output, with the vertical dimension stretched by the same amount (and possibly clipped).
V-fit	The source is stretched to fill the vertical dimension of the output, with the horizontal dimension stretched by the same amount (and possibly clipped).
1:1	Each source pixel is represented by a single output pixel – no scaling will be performed. If the input resolution is higher than the output, then only part of the source will be seen. If the input resolution is lower than the output, then a black border will be present.

Source: RGB1 TL pos. adj. [0] [0]

This menu item allows manual positioning of the Top and Left portion of the image. It is used to ensure that the input signal is captured correctly, eliminating any black borders. These settings are often used to correct the position of a PC signal on an input, or to eliminate any undesired noise at the top or bottom of a PAL or NTSC video source.

Source: RGB1 BR size adj. [0] [0]

This menu item allows manual positioning of the Bottom and Right portion of the image. These settings are often used to correct the position of a PC signal on an input, or to eliminate any undesired noise at the top or bottom of a PAL or NTSC video source.

Source: RGB1 Audio input source [1]
--

If your unit has an internal audio switcher / selector, this menu item selects the desired Audio input for use with the active video source, allowing an audio-follow-video function.

Source: RGB1 OPTION audio source [1]

If an external audio switcher is connected via the OPTION bus, then this menu item selects the desired Audio input for use with the active video source, allowing an audio-follow-video function.

C2-2375A SERIES OPERATION MANUAL

In most situations, the Audio input values would be different for each video source – so that when the first video source is selected, so is the first audio source (this is called ‘audio follow video’). The second video source then selects the second audio source, etc. However, there is nothing to prevent all Audio input values being set to the same value, for ‘audio breakaway’.

Source: RGB1
 Audio Vol [1] Bal [0]

This menu item adjusts the audio volume and balance for the selected audio channel. This is only functional for certain units when an optional Audio Switcher is attached.

Source: RGB1
 On source loss [Blue]

(This has replaced ‘De-glitch’ used on previous firmware versions.)
 This option is used to tell the unit what to do if the video source is lost or becomes unstable. Options are:

Option	Description
Show	Shows all picture break-up and instabilities.
Freeze	Freezes the latest frame – un-freezes as soon as the source becomes stable again.
Blue (default)	Turns the window blue, to represent source loss.
Black	Turns the window black.
Remove	Removes the window, thus showing any background (e.g. a Lock source). This is useful for MIX & PIP scenarios on units with overlay abilities.

If you have a very unstable input, such as a video tape player with a poor (jumping) output signal, you may wish to turn the setting to ‘Show’.

Source : RGB1
 De-int [M.comp med]

An interlaced input consists of two fields separated in time. Both fields are required in order to make up the full resolution input image, but since they are sent one after the other, a moving image will have “motion artifacts” if the two fields are simply combined together. The most common artifact is a blurring at the point of maximum movement within an image. Your unit provides some tools to minimize the effects of de-interlacing of an image.

The following options are available for this menu item:

C2-2375A SERIES OPERATION MANUAL

Mode	Function
Normal/weave	The two interlaced fields are simply combined/weaved together. This will often show artifacts on moving images, but can be used when the input is known to be still.
Auto	Automatically selects Film 3:2 or Medium Range Motion Compensation (M. Comp Med.) depending on whether Film Mode is detected or not.
Film 3:2	Enables 3:2 pull down conversion of the incoming NTSC video. (This option should not be used if the source is not NTSC video).
M. Comp Low M. Comp Med. M. Comp High	Enables Pixel Adaptive Motion Compensation. Three levels are available with 'Low' providing the least compensation for Motion and 'High' providing the most compensation.
Frame/bob	The two fields are shown consecutively.

Source : RGB1 Diagonal interp.	[Off]
-----------------------------------	-------

This menu item allows the user to specify whether the source has diagonal interpolation applied to it when de-interlacing occurs. This reduces 'jagged' artifacts on moving images, however is not suitable for noisy sources where the noise could be mis-interpreted as a diagonal or sloping element of the picture.

Source : RGB1 Noise reduction	[Off]
----------------------------------	-------

This menu item allows the user to specify whether the source has noise reduction applied to it. This is performed by averaging the video signal over a number of fields – but ignoring areas where motion has occurred. If motion blurring is seen, it is recommended to turn this setting off.

8.6.2 DVI Source Menu Items

Source: DVI1 HDCP	[Inactive]	[Off]
----------------------	------------	-------

HDCP is supported on certain units only - and only on the DVI input connector. This menu item lets you change whether HDCP is active on this particular DVI input.

If turned 'Off', then a source that requires HDCP encryption will not send a video signal to your unit.

If turned 'On', and a HDCP-compliant display or device is attached to your unit's DVI output, then HDCP encrypted sources can be used.

The following table summarizes the message given in brackets:

C2-2375A SERIES OPERATION MANUAL

Status message	Description	Effect
Inactive	HDCP is not active at the DVI connector.	HDCP-encrypted material cannot be received by the unit.
Active	HDCP is active at the DVI connector.	HDCP-encrypted material can be received by the unit, but only if a HDCP-compliant display or device is attached to the unit's output.

See 'Adjust outputs' for a description of how the HDCP system works on your scaler.

Source: DVI1 Display emul. EDID [DVI]
--

This feature is only present on certain units – it is used with the next menu item to form a simple 'EDID Manager'.

EDID is an information packet retrieved by a PC graphic card over a DVI link from a monitor which tells the graphic card which resolutions the display supports. In the case of your unit, it tells the graphic card what resolutions are compatible with it – by emulating a display.

The above menu lets the user select which of 8 EDID data blocks are 'shown' to a PC or other DVI/HDMI source. (It does not affect any other input.) Note that some graphic cards will usually only read the EDID data when the cable is first connected, or on power-up.

The 8 EDID blocks are as follows:

EDID	Usage
Mem1	User-definable – see 'EDID capture'
Mem2	
Mem3	
Mem4	
Mem5	
Mem6*	
HDMI*	Default HDMI EDID data for your unit
DVI	Default DVI EDID data for your unit
Mon	The attached monitor's EDID data

*Your unit will have either Mem6 or HDMI, but not both.

If you change this value, you'll need to store your settings and then re-boot the CORIO2 unit at least once to ensure that the source sees that the EDID data has changed.

It should also be noted that some graphic cards will require your PC to be re-booted before they see that a change has occurred.

If your unit allows 'HDMI' to be selected, this can also enable certain audio features depending on the abilities of your unit.

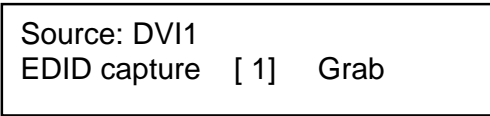

This menu provides a simple way of capturing EDID data from an attached DVI or HDMI monitor and storing it in one of the user-definable EDID memory data blocks (Mem1 to Mem6) – see previous menu.

To capture a different display's EDID, perform the following:

1. Connect that display to the DVI output of the CORIO2 unit - the CORIO2 unit will then read it automatically and store it in the 'Mon' EDID entry.
2. Select which EDID memory (Mem1 to Mem6) to copy this information to.
3. Select 'Grab' and click on it - this will copy the current monitor's information to that EDID memory.
4. Change 'EDID to use' to that memory location (Mem1 to Mem6).
5. Store your unit's settings (see earlier in this manual on how to do this).
6. Re-boot (turn off and on again) the CORIO2 unit to ensure that the graphic card uses this new EDID data (you may need to re-boot your computer as well).

Using the above, up to 6 custom EDID settings can be stored in the CORIO2 unit, ready for recall later. This is useful to simulate another display being attached to a graphic card.

8.6.3 RGB Source Menu Items

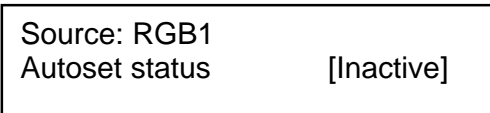

Once the Autoset sense setting has been made, this menu item is accessed and activated. The Autoset sense utility will then correct the pixel phase and then position the Top Left portion of the image and the Bottom Right portion of the image. Once complete it then resume inactive status.

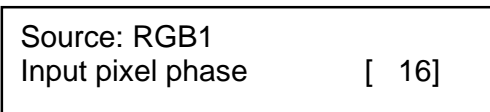

Since an image pixel is a very small element of the total image, it's possible for your unit's Analog to Digital converters to wrongly sample the picture on the edge of each pixel thereby losing image resolution and creating image noise. The Input

pixel phase adjustment allows you to change the position (from 0 to 31) where the pixels are sampled, relative to the horizontal sync signal.

To make this adjustment, select an RGB source and then provide an image from that source with fine detail, preferably with very sharp vertical lines. Adjust this value until you see the sharpest image. Alternately, adjust this value to give the worst (noisiest/softest) image, and then add or subtract 16 to get the optimum value.

Note that the AUTASET function (for RGB inputs only) will attempt to automatically work out the best value for this setting.

Source: RGB1 RGB input type [RGBHV]

There are several types of signals that are called RGB signals as a generic term. Each has slightly different characteristics that set it apart from similar RGB signals – such as how the synchronization signal is sent. This menu item lets you set the input type to use.

Available options let you select whether the input is standard RGB or YUV (including YPbPr signals with a tri-level sync). For some units, it also allows selection of break-out BNC connectors to be used instead of the normal connector (signified by B- in front of the signal type).

Source: RGB1 RGB contr. [100] [100] [100]

This menu item lets you adjust the individual RGB or YUV/YPbPr signals, in case one component is at a different contrast to other, or if they all need to be boosted or lowered.

8.6.4 CV & YC Source Menu Items

Of the above Source Menu items, the Autoset sense and Autoset status functions, RGB type and Pixel phase are specific to RGB signals only. The rest of the Source menu items function with RGB, CV or YC type signals. In addition, there are four additional Menu items that are only used with CV or YC type signals and these are explained below:

Source: YC1 Bright [100] Contrast [100]

Adjust the Brightness and Contrast of the image to your requirement.

Source: YC1 Satur [100] Hue [0]

Saturation is the amount of color present in the image. Hue is the color “tint” parameter and the adjustment range is +90 degrees through to -90 degrees with 0 being the default.

Source: YC1 Sharpness [0]

Within limits, you can enhance or soften the appearance of detail within an image. The Sharpness values go both negative and positive, with 0 being the default. Note that over-enhancing an image has the side effect of making it appear to be noisy and under-enhancing an image gives the appearance of poor video quality.

Source: YC1 Luma delay [0]

On occasion, a video source will have the color portion of the signal offset from the luminance portion. If you've ever seen a poor quality comic book that has the outline of the cartoon character's head in one place on the page but the flesh tones for the head offset slightly, you are seeing the print equivalent of Luminance to Chrominance Phase Delay.

Fortunately, your unit provides a way for you to make the two signals occur at the same time on the selected image. The adjustment range provides both positive and negative levels of delay with 0 being the default.

8.6.5 Still Image Store / Testcard Source Menu Items

Source : TC1 Testcard [0]

This item is only available for units supporting Still Image Stores (SIS) or Testcards (TC) – which are the same thing, but may be named differently depending on your unit.

Used to select the image from memory to use as a source for the SIS / TC source currently selected. Dedicated software can be used to upload user-defined images – see our website.

8.7 Items associated with the Adjust transitions group

Please note that not all units have this sub-menu – it is only available on some units with overlay and keying abilities.

Transitions control how your unit responds when a source is changed. Fades between sources, as well as wipes and cuts, are possible. The amount of time taken by a transition is controllable from instant transition (a ‘cut’) to several minutes.

Adjust transitions Transition	[Fade]
----------------------------------	--------

This first adjustment controls the type of transition desired: 'Cut', 'Fade', 'Wipe' or 'Push'.

If you select 'Cut' or 'Fade', the only remaining menu items will be 'Switching Fade Time' and 'Exit'. Selecting 'Wipe' or 'Push' exposes additional parameters.

Adjust transitions Switching fade time	[.5]
---	------

This parameter controls how long a transition from one input to another takes. The value can be 0 (a cut) or several minutes - adjustable in 1/10th second increments.

Adjust transitions Wipe type	[Left -> Right]
---------------------------------	-----------------

If you selected 'Wipe' or 'Push' for the transition type, then you will be able to specify the 'movement direction' of the transition that you want. Both 'Wipe' and 'Push' support: Left to Right, Right to Left, Up/Down (Top to Bottom), Down/Up (Bottom to Top). 'Wipe' also supports: Diagonal and Diamond effect.

Adjust transitions Wipe size	[100]
---------------------------------	-------

Wipe Size sets the 'granularity' of the 'Wipe' effect and so is only shown when 'Wipe' is the transition type. The smaller the number, the more elements there are to the wipe. To clarify by example, if you select the Diamond wipe effect and set a small number into the Wipe Size parameter, you will have a large number of Diamonds present in the transition. On the other hand, a large number loaded into the parameter will result in only one or two diamonds being present during the transition.

8.8 Items associated with the Adjust ethernet group

(Please note that not all units have this sub-menu.)

Your unit can be remotely controlled via its RS-232 serial port, but some units can also be controlled via a Local Area Network using the Ethernet connector. This provides TCP/IP communications to and from the unit using a custom protocol.

In most networks, all computers and other electronic equipment will have a dedicated connection to a network hub or switch, with each item having its own 'IP address' (Internet Protocol address). This is the unique set of numbers that identifies the item on the network.

The network itself is usually segmented into a number of sub-networks. Small offices will generally just use one sub-network, with larger ones running many sub-networks that are linked together across a sub-network bridge. Sub-networks are split up by assigning different ranges of IP addresses to the different sub-networks. The ranges are defined by the 'sub-net mask'.

In very simple setups with 2 pieces of equipment (e.g. a computer and one other piece of equipment), it is possible to link the two together using just a cable (which must be a cross-over cable). However, this setup is rare.

Where only a single sub-network exists (as in the majority of cases) it is vital that:

1. All equipment has different IP addresses.
2. All IP addresses are part of the same sub-net.
3. All equipment has the same sub-net mask.

In most situations the computer will already be attached to a network, and therefore its IP address and sub-net mask will be easily accessible (e.g. in Windows XP you can right-click on the network activity icon to see the Support status, or check the Network Connections in the Control Panel and right-click the 'Local Area Connection').

An IP Address then needs to be assigned to your unit. Typically this will be by changing the last of the 4 values (that are separated by dots) to one that is not yet in use. The 'IP add' menu item is used to enter this into your unit.

The sub-network's 'sub-net mask' then needs to be copied to the 'IP sub' menu item listed below.

For simple setups (where only a single sub-network is in use), there is no need to change the IP gtwy (gateway) numbers.

Adjust ethernet IP enabled	[Auto]
-------------------------------	--------

This parameter has three possible states: On, Off and Auto. On and off manually control the Ethernet capability of the unit. When in Auto mode, if a valid Ethernet connection is present, remote control of the unit will automatically default to Ethernet and control via RS-232 is disabled whilst that connection is maintained.

Adjust ethernet IP add.	[10] 1 2 123
----------------------------	---------------

Enter 4 numbers one by one to form the IP address you wish to assign to the unit. The IP address is a series of four numbers between 0 and 255. Anything above 255 is not a valid number in an IP address range. The unit will not allow you to go above 255.

The IP address must be a unique address on your network, and also must be within the sub-net of your network. If you are unsure about which IP address to use or don't have a unique IP address, ask your Network Administrator.

Adjust ethernet IP sub. 255.255. [255.000]

Adjust the last 2 numbers to set the sub-net address (also know as sub-net mask) of your network. Again, if in doubt ask your Network Administrator.

Adjust ethernet IP gtwy. [10] 1 2 123

Enter your network's gateway IP address into this menu item. Again, if in doubt ask your Network Administrator. In general, the gateway only needs setting if the unit is being controlled from a different network (e.g. via the internet).

Adjust ethernet IP port [10001]
--

Enter the IP port number you wish the unit to communicate on. Keep a note of this as it will be needed when using other devices to communicate with the unit e.g. CC-300.

1A Adjust Ethernet Set new IP data & reboot
--

Certain units require a re-boot once the new IP address has been entered. Once activated, all current settings (including other menu items) will be saved and the unit will re-boot. If you do not see this menu item, then your unit has already implemented your changes and no re-boot is required.

8.9 Items associated with the Adjust resolutions group



The Adjust Resolutions Menu Group only appears when the Advanced Menus function is turned on within the System Menu Group. To turn it on, go to the System Menu Group and then proceed to the item that says "Advanced Menus". Turn the function 'On', exit the Systems menu and return to this menu structure.

The Resolution Database is used by your unit to identify any incoming video signal and is also used to create an output resolution. It is therefore a very important part of the unit's infrastructure.

Important Cautionary Information

DO NOT ADJUST THESE ITEMS UNLESS YOU'RE CERTAIN YOU KNOW WHAT YOU'RE DOING! THE ONLY METHOD TO UNDO CERTAIN CHANGES IS TO UPDATE THE FIRMWARE.

TRY USING THE AUTOSET, SHRINK, SHRINK POS, TL & BR ADJUSTMENTS FIRST.

Making adjustments here risks creating a non-standard resolution that is not displayable on a monitor. The resolutions and values within the database are industry standards and should not normally be altered by the user. That said, there might be times when it is necessary to create a custom resolution with specific parameters. If circumstances require you to make such a change, please read the following specific notes:

1. Any changes made to this database take effect instantly and are also stored immediately in non-volatile memory.
2. Since this database is used for both input and output image processing, altering a resolution that is used for both (e.g. 1024x768 input and 1024x768 output) may give undesired effects.

800 x 600 60 Hz Image to adjust	[17]
------------------------------------	-------

Change the value to select resolution you want to alter.



Typically, the image number currently being used for input or output would be already be selected otherwise immediate feedback to your changes will not be available via your monitor.

800 x 600 60 Hz Interlaced	[Off]
-------------------------------	--------

This adjustment specifies whether the image is interlaced or progressive scan. It toggles simply On or Off, so there are no flashing brackets.

800 x 600 60 Hz H.freq.crse	[37.879] kHz
--------------------------------	--------------

Course Frequency Adjust

The H freq.crse (Horizontal Sync Frequency - Course) adjustment provides the option for changing the Horizontal Sync timing Frequency in 100 Hz steps.

800 x 600 60 Hz H.freq.fine	[37.879] kHz
--------------------------------	--------------

Fine Frequency Adjust

The H.freq.fine (Horizontal Sync Frequency) adjustment provides the option for changing the Horizontal Sync timing Frequency in 1 Hz steps. Use this option to fine tune after using the course adjust.

Please note that the internal sync generator may be unable to generate the exact frequency you want.

800 x 600 60 Hz Clks/l [1056] =	40.000MHz
------------------------------------	-----------

This option changes the total number of image pixels on one line of monitor video including the Horizontal sync pulse and blanking time. This is normally in a multiple of 8. It is very important to get this value correct, or many digital display devices, such as TFT monitors, will display an image with an odd moiré effect – such as soft vertical bands spread evenly across the image.

800 x 600 60 Hz Lines/f [628] =	60.317 Hz
-------------------------------------	-----------

This menu controls the total number of lines of video present in the image which includes the vertical Sync pulse, the blanking period and the active video. Changing this option affects the final vertical sync frequency.

800 x 600 60 Hz H/V active	[800] x 600
-------------------------------	--------------

A video frame includes both the active area, the portion of the image normally containing useful visual information, and a resolution value for a given display standard which only expresses the number of pixels visible in an image. The well-known 800 x 600 computer resolution standard simply means that there are 800 pixels/line visible horizontally and there are 600 lines visible vertically.

This item provides a way to change the number of active pixels and lines.

800 x 600 60 Hz H/V Start	[88] x 23
------------------------------	------------

There is a period of time between the end of the Horizontal Sync pulse and the start of Active Video. This portion of the waveform signal is called the “Back Porch”, a term originating with the television broadcasting industry and its RS-170A specification. In practice, this will control where the video image starts on the left side of the monitor without changing the width of the sync pulse itself (another way to control where the image area starts). The two parameters control where the back porch is positioned and they interact to a degree.

By adjusting these parameters, you control the start of the back porch (with respect to the trailing edge of Horizontal Sync) and also its width. The place where the Back Porch begins with respect to the Horizontal Sync pulse and the width of the Back Porch have a direct bearing on where the active (visible) portion of the image begins. Do not attempt this adjustment without monitoring the results with an oscilloscope.

800 x 600 60 Hz H/V Sync	[128] x 4
-----------------------------	------------

There are standards for all current computer and broadcast resolutions that specify the correct width of both Vertical and Horizontal synchronizing pulses.

If you are creating a special, non-standard resolution, you may wish to adjust the pulse width to fit your new requirements. The H/V Sync screen is where that is accomplished.

Like the H/V Start adjustment, you must use an oscilloscope when making these adjustments so that you know exactly how many milliseconds or microseconds of pulse width you have created. The numbers shown are relative numbers and not an actual time measurement.

800 x 600 60 Hz Sync polarity	[+H+V]
----------------------------------	--------

Sync can be either negative polarity or positive polarity. To further complicate things, it is possible that you may want to make the Horizontal Sync polarity different from the Vertical Polarity. This control allows you to make that change. You have four possible selections:

- +H+V
- H+V
- +H-V
- H-V

8.10 Items Associated with the System group

The final Sub Menu is for adjustments of System parameters. The “System” in this case means the unit’s functions that are generally unrelated to individual inputs, outputs or any of the various production features.

System SW: 16, PT: 12, BT: 13

This screen is an informational screen. Should you require technical assistance with your unit, the technical support personnel may request that you read the contents of this screen to them during the support call.

The first section, “SW”, is the version of the software that is installed on your unit. You can update software via the User Support web site (procedure to be described later in this manual) and the updates are currently free of charge. “PT” refers to Product Type and “BT” means Board Type. Both of these are hardware designators and cannot be changed by the user however both designators are important to support personnel.

System SW date:	2006-7-11
--------------------	-----------

This is an information page showing when the currently installed software was released. The information is useful to the user as he or she compares the date to the website information describing the current software release.

Normally, the user will examine the added features of each new software release and determine if an update is worth doing in their particular operation. The greater period of time between the current date, and the date shown for the currently installed software, the greater the likelihood that there are useful changes and improvements present in the new release.

System TAC#	27-AA-1C-93-F8-33
----------------	-------------------

The TAC number is a unique identifier for the unit and is for use with the PPF value below.

System PPF#	1A-67-2B-9D-50-4F
----------------	-------------------

The PPF number is for units that support the 'Pay Per Feature' system. Extra features in the unit (such as Mix and Key) may be activated using this menu item by entering in the correct numbers and re-starting the unit.

System Push to store	
-------------------------	--

This screen provides a quick and easy way to store all current operating parameters. The unit will remember the set up you are currently using at the time of data storage and also when you next apply power. To store the current settings, press and release the control button.

System Autoset sense	[Medium]
-------------------------	----------

In order for Autoset to work properly, it needs a sufficiently bright full-screen image to examine. The sense level lets you change the brightness threshold for detection of the screen edge between Low, Medium, High and V.high. Medium is the default level, which is recommended for normal use (Windows-type images, etc.)

System OSD on power up	[On]
---------------------------	------

This parameter controls whether the 'welcome' screen is displayed or not on power up for units with an on-screen display – it can be disabled as required. This is useful when a unit is installed as part of an overall system.

System LED brightness %	[90]
----------------------------	-------

This parameter is available on certain units and controls how bright the LEDs on the front panel appear.

System LCD backlight	[On]
-------------------------	------

This parameter is available on certain units and allows the LCD backlight to be turned on and off.

System LCD contrast	[200]
------------------------	-------

This parameter is available on certain units and allows the LCD contrast (viewing angle) to be altered.

System LED brightness %	[90]
----------------------------	-------

This parameter is available on certain units and controls how bright the LEDs on the front panel appear.

System Serial type	[RS-232]
-----------------------	----------

This menu item controls the type of serial port in use on certain units (not all units support this feature). Options available are RS-232, RS-422 and RS-485. The default is RS-232.

System RS232 baud rate	[57600]
---------------------------	---------

This menu item allows the adjustment of the serial baud rate used for RS-232 communications. The rate can be adjusted to 9600, 19200, 28800, 33600, 38800, 57600 and 115200. (This adjustment is provided for those instances where you wish to use the RS-232 control system for your own purposes.) The default baud rate is 57600.

System Buzzer	[On]
------------------	-------

The screen labeled 'Buzzer' is actually the control for turning the "Beep" "On" or "Off". Normally this is left in the "On" position to provide positive feedback that your data entries and parameter changes have been accepted.

System CC-300 A/B bus mode	[Off]
-------------------------------	--------

This menu item changes the function of an attached CC-300 CORIO console unit. When set to 'On' any 'Take' will result in the A & B windows ('buses') being swapped at the end of the Take – so that another 'Take' will put them back to as they were before. (Note that not all units support the CC-300.)

System Resolutions	88
-----------------------	----

This screen is an informational screen showing the total number of the defined resolutions in the resolution database. Future firmware releases may increase the total number of resolutions defined in the database.

System Logos / T-cards	1 / 4
---------------------------	-------

If your units supports Logos or Still Images / Testcards then this screen will display how many are present in the memory of the units.

System Power cycles	41
------------------------	----

Power Cycles refers to how many times the unit has been powered since it left the factory. This is an informational screen. No action is taken regardless of the value shown here, however some users have an equipment cleaning or specification audit procedure and this information may be useful to those users.

System Firmware updates	11
----------------------------	----

Indicates the total number of times the firmware has been changed over the life of the unit. It is quite possible for this to be more than 1, as a unit undergoes numerous tests during production.

System Hours in Use	877
------------------------	-----

This is another informational display for usage audit purposes.

System Temp.C	30 33 43 45
------------------	-------------

Certain units have built-in temperature sensors, and if yours has such a feature then the above menu item will appear. If the ambient temperature of the internal components becomes excessively high or low, the unit will shut down to prevent harm. This display shows the current value of the ambient temperature at four locations within the case and can be an early predictor of a shutdown before the shutdown actually occurs.

Should you experience problems with your unit, Technical Support may request that you give details of these values.

System Fan speed (rpm)	6000
---------------------------	------

Certain units have built-in fans to keep the unit cool. The fan speed is monitored and if it deviates from normal parameters too much, this will be taken as an indication of insufficient airflow over critical components and shutdown action will be taken.

9 SERIAL PORT

9.1 Connection

Your unit is fitted with a standard 'D9' plug or socket allowing it to be controlled from a computer or other type of terminal or console with a similar interface. Most computers fitted with an RS232 port, known as a 'COM' port, will have a 'D9' plug on them. To enable connection between the two devices you will require one of two cables as shown below:

D9 connector type on C2 unit	RS232 cable type required for linking to PC
Plug – common on earlier C2 units	'Null-modem' D9 socket to socket
Socket – common on recent C2 units	D9 plug to socket

Should your PC not have an RS232/COM port, it is possible to add an interface card into the PC to add this facility. Another option you could use is a USB to RS232 converter. Both methods will add a COM port to your PC, although you should be aware that these generally do not default to being 'COM1' which is the default most RS232 applications will use.

Some units are also RS-422/485 capable – see the Specifications section for more details.

The default baud rate is 57600 with 8 data bits, 1 stop bit and no parity. This baud rate can be changed in the System menu to suit other programs if need be.

9.2 Communications protocol

The standard communications protocol for your unit is text-based and is detailed on our website. Also on our website, you can find the Windows Control Panel or CORIO®tool Suite for your unit.

The protocol is also bi-directional (unit and computer both send messages to each other), so that you can send changes to the unit, and it will also respond with any changes made via alternate methods (front panel buttons, menu changes and infra-red control). This enables any attached computer to be aware of any changes made to the unit from an alternative source rather than itself.

What this means is that you can easily find out the exact command to send to the unit to tell it to perform a certain function. This can be seen by the data that is sent back to the computer when changing values on the unit. For instance, just by turning FREEZE on, by pressing the FREEZE button, will cause RS232 data to be sent to the computer that represents the command required to set FREEZE on. A second press, to turn FREEZE off, then sends the computer the command required to turn the FREEZE off.

C2-2375A SERIES OPERATION MANUAL

Note: Any command you send to the unit will be replied to either with an error code or with the actual changed value. This may be different to the one you sent; for example, if trying to set a value too high or too low.

10 SERIAL / IP CONTROL SPECIFICATION

PLEASE NOTE: Not all units support Serial and/or IP (Ethernet) communications – check to see if this feature is present on your unit.

This section outlines how to control a unit via a Serial or Ethernet link (if fitted to your unit), using ASCII-based commands. It details how to send and receive serial data to perform many of the functions that a user has access to on the unit.

Not all units will support the full range of adjustments listed – this will depend on the complexity of the unit you have.

10.1 Communication protocol basics

Packets of ASCII data containing hexadecimal numbers are exchanged between the unit and controller via a Serial or IP link (you cannot use both at the same time).

The Serial standard is 57600 baud, 8 bits, no parity and 1 stop bit, although this can be changed by the user (see 'System' menu).

No flow control is used - however all control packets start with an ASCII 'F', end with carriage-return (13 decimal, 0x0D hexadecimal) and all such packets sent to the unit will be acknowledged (thereby provided software handshaking). Note that a line-feed (LF) should not be sent.

It may take around 30ms (0.03 seconds) for an RS232 command to be actioned and acknowledged – this will vary between different models.

ASCII-hex data is used where a number is encoded into its hexadecimal equivalent with leading zeros – e.g. Where '00' is decimal value 0, '80' is decimal 128 and 'FF' is decimal 255. In other words, two characters are sent for each byte encoded.

Any gap of more than 1 second between the characters of a control command sent will cause a time-out - and previous characters sent will be lost.

Write packets (sending command functions to the unit) are always 20 characters long (including a carriage return at the end). The unit will respond with a full 20 character message indicating what has changed. This returned payload will reflect the actual value of the parameter changed. If the user requests a value out of bounds then the limit value is used, and the payload will then reflect the limited value used.

Read packets (sent to request information from the unit) are always 14 characters long (including a carriage return at the end), the response from the unit will be a 20 byte message with the Write flag (since it is 'writing' the value back to the host) and the ACK flag set.

C2-2375A SERIES OPERATION MANUAL

The ACK flag will be returned as 0 if the command is invalid for some reason – for example a bad FUNCTION, WINDOW, OUTPUT or PAYLOAD value. An ACK=0 message will be otherwise identical to the one you sent, so you know exactly which message has the error.

Any changes made to the unit using the front panel controls will also cause the full 20 byte message to be sent indicating the change that has occurred, thus enabling a program to stay 'in-sync' with the unit. In some cases (such as the execution of a macro) multiple 20 bytes messages will be sent indicating all the parameters that have been changed.

Only one message should be sent to the unit, another message can't be sent until a specific response is received from the unit (the user should look for a message with the same WINDOW, OUTPUT and FUNCTION values as they sent). If no message is received back within 1 second, there is likely to be a hardware communication problem (or wrong baud rate, etc.).

If absolutely required, to simplify programming the user may send packets one after the other with around 100ms (100 milliseconds) between each one. However, this will not work for all packets (such as Zooming into Still Images / Testcards or changing Logos) since this will cause the unit's micro-controller to be busy, so the user must experiment and satisfy themselves that this is possible.

10.2 Packet format

Below is a representation of data bytes in a single packet for a 'Write' to the unit to set a value:

SOP	CMD	CHA	WINDOW	OUTPUT / FUNCTION	FUNCTION	PAYLOAD x 3	CS	EOP
-----	-----	-----	--------	----------------------	----------	-------------	----	-----

Below is a representation of data bytes in a single packet for a 'Read' to the unit to get a value:

SOP	CMD	CHA	WINDOW	OUTPUT / FUNCTION	FUNCTION	CS	EOP
-----	-----	-----	--------	----------------------	----------	----	-----

The table below details the function of each part of the packet:

Packet part	Function
SOP (Start of packet)	This is always the ASCII letter 'F' to indicate the packet start.
CMD (Command)	ASCII-hex byte to indicate the type of command being sent. Each bit in the byte has a different function. Currently only the following bits are defined: Bit 7 = Write (0) or Read (1) request. Messages from the unit are always Writes. Bit 6 = ACK bit. Should be set to 0 for messages to the unit. ACK=1

C2-2375A SERIES OPERATION MANUAL

	<p>returned means message was okay. ACK=0 returned means an error was present in the message.</p> <p>Bit 5 = 0 Reserved for future use. Bit 4 = 0 Reserved for future use. Bit 3 = 0 Reserved for future use. Bit 2 = 1 This bit *must* be set. Bit 1 = 0 Reserved for future use. Bit 0 = 0 Reserved for future use.</p>
<p>CHA (Channel)</p> <p>SOURCE</p> <p>or</p> <p>MACRO NUMBER</p>	<p>This byte has multiple uses, and defaults to 0 unless used for:</p> <p><u>CHA</u> When a channel number is used in the Adjust Sources section (see later).</p> <p><u>SOURCE</u> Byte to indicate the source channel to be altered (if appropriate). 0x10 = RGB1, 0x11 = RGB2, 0x12 = RGB3, etc. 0x30 = CV1, 0x31 = CV2, 0x32 = CV3, etc. 0x40 = YC1, 0x41 = YC2, 0x42 = YC3, etc. 0x50 = SDI1, 0x51 = SDI2, etc. 0xD0 = OUT1, 0xD1 = OUT2, etc. 0xF0 = TC1, 0xF1 = TC2, etc.</p> <p><u>MACRO</u> Or – for Macro related commands: Bit 7..4 = 0 Reserved Bit 3..0 = Macro number</p>
<p>WINDOW / LOGO / BORDER</p>	<p>Bit 7 = 0 (Reserved). Bit 6..0 = Represents the window to be adjusted (for multi-channel units only). E.g. Window 'A' (the default for single-channel units) is sent as '41' since 0x41 is ASCII for 'A'. 0x61 is ASCII for 'a' (a Logo) and is sent as '61'.</p>
<p>OUTPUT & FUNCTION HIGH</p>	<p>Bit 7..4 = Number representing the output to adjust 0 = Output 1, 1 = Output 2 (for multi-channel units). Bit 3..2 = Reserved (set to 0). Bit 1..0 = Bits 9 & 8 of the function code. (Remainder of bits [7..0] are in FUNC LOW.) E.g. If the function code is 0x234, and we want to adjust Output 2, then this byte is 0x12</p>
<p>FUNCTION LOW</p>	<p>ASCII-hex byte to indicate the lowest 8 bits of the actual function to set or receive (e.g. change Zoom value). A later table details all the functions available.</p>
<p>PAYLOAD x 3 bytes</p>	<p>A series of ASCII-hex bytes carrying the data to send. Read requests have no payload - the payload is in the data sent back. Write packets require a payload, and this is always in 'triple-bytes' - i.e. 3 bytes are required, MSB first. e.g. '000001' is 1 in decimal, '010000' is 65536 in decimal, and 'FFFFFF0' is -16 in decimal.</p>

C2-2375A SERIES OPERATION MANUAL

CS	ASCII-hex byte that is the (check) sum of all previous bytes (excluding the SOP 'F' character). E.g. The command F0400410082000001C8 has the checksum of 04+00+41+00+82+00+00+01=C8, so the complete command to send is F0400410082000001C8. A short-cut for debugging allows the checksum to be replaced by 2 question marks, so in the previous example you could send F0400410082000001??. Instead. This is purely for test and debugging - you should normally use a checksum to ensure data validity.
EOP	This is a carriage return (no line-feed) - ASCII code 13 (decimal).

10.3 Function list

These are grouped together into their associated on-screen menus.

Your unit and this manual should be used to determine the actual function of each of the following, as only the menu text is listed here. Where an equivalent menu item does not exist on your unit, then that feature is not supported on.

Function codes are given in hexadecimal and adjustment range is in decimal (but always sent as hexadecimal!).

For dual-channel units the mode of operation also restricts what Window and Output can be used the following table shows the allowed combinations:

Mode	Allowed Window and Output combinations
Switcher	Output 1 (0x00) and Window A (0x41) / Z (0x5A) / Logo a (0x61)
Independent	Output 1 (0x00) and Window A (0x41) / Z (0x5A) / Logo a (0x61) OR Output 2 (0x01) and Window B (0x42) / Z (0x5A) / Logo b (0x62)
Dual PIP	Any combination of Output and Window

The following table is a list of all menu functions, their related function number and valid range of adjustment.

Please note that not all items will be available on all units.

Menu text	CHA	FUNC (Hex)	Range of adjustment (decimal)
Top level			
Mode (Dual-channel units only)		109	0 = Switcher 1 = Independent 2 = Dual PIP
Preset number		225	1 to 10
Preset load		226	Set to 1 to load – automatically resets to 0.
Preset store		227	Set to 1 to store – automatically resets to 0.
Preset erase		228	Set to 1 to erase – automatically resets to 0.

C2-2375A SERIES OPERATION MANUAL

Adjust outputs			
Output enable		170	0=Blanked, 1=Active
Lock source (connector)		149	0x10 to 0x1F = RGB1 to RGB16 0x30 to 0x3F = CV1 to CV16 0x40 to 0x4F = YC1 to YC16 0x50 to 0x5F = SDI1 to SDI16 0xD0 = OUT1, 0xD1 = OUT2 0xF0 = TC1, 0xF1 = TC2
Lock method		10A	0 = Off 1 = Genlock 2 = Lock & Mix 3 = DARSlock (some units only) 4 = Frm.lock (some units only)
Lock H Shift		14A	-4096..4096
Lock V Shift		14B	-4096..4096
Output resolution		083	1..1000
Output image type			See Adjust resolutions entries
Output image type digital		16C	0 = RGBHV 3 = YUV 9 = Not available
HDCP required		233	0..1, Off, On (if display supports it)
HDCP status		234	0=Unavailable 1=Supported 2=Active 3=Repeater supported 4=Repeater active 5=No display (Other values indicate various HDCP authentication states.)
Background Y		13B	16..235
Background U		13C	16..240
Background V		13D	16..240
SDI optimization		197	0..1, Off, On
Output Standard		101	0 = NTSC/PAL, 1 = PAL-M/PAL-N, 2 = SECAM
Output CV/YC IRE		133	-7.5..12.5
Output CV/YC Hue (degrees)		139	-22..22
Output SC/H Phase		085	-180..180
Output Luma Bandwidth		134	0,1,2 = Low, Medium, High
Output Chroma Bandwidth		135	0,1,2 = Low, Medium, High
Output Chroma delay		137	-4..3
PAL WSS		130	0 = Off 1 = 4:3 Full format 2 = 14:9 Letterbox centre 3 = 14:9 Letterbox top

C2-2375A SERIES OPERATION MANUAL

			4 = 16:9 Letterbox centre 5 = 16:9 Letterbox top 6 = >16:9 Letterbox centre 7 = 14:9 Full format 8 = 16:9 Full format
Take		11E	0->1 = Perform a Preview -> Program transition
Audio amp. Volume		201	-16 to 15
AES/SDI Chan. 1 source		20B	0x00 to 0x07 = SDI1-1 to SDI1-8 0x08 to 0x0F = SDI2-1 to SDI2=8 0x10 to 0x1F = AES1 to AES16 0x20 = AFV (audio follow video)
AES/SDI Chan. 2 source		20C	
AES/SDI Chan. 3 source		20D	
AES/SDI Chan. 4 source		20E	
AES/SDI Chan. 5 source		20F	
AES/SDI Chan. 6 source		210	
AES/SDI Chan. 7 source		211	
AES/SDI Chan. 8 source		212	
Adjust windows			
Program source / Window source (connector)		082	0x10 to 0x1F = RGB1 to RGB16 (Also includes DVI / YUV sources) 0x30 to 0x3F = CV1 to CV16 0x40 to 0x4F = YC1 to YC16 0x50 to 0x5F = SDI1 to SDI16 0xD0 = OUT1, 0xD1 = OUT2 0xF0 = TC1, 0xF1 = TC2
Select Universal source		241	0xE0 to 0xEF select universal inputs 1 to 16
Source resolution		0F8	Read only – returns # of resolution
Window Enable		12B	0..1 = Off, On
Zoom level %		086	100..1000
Zoom level H %		103	100..1000 (only used in Advanced A/R mode)
Zoom level V %		105	100..1000 (only used in Advanced A/R mode)
Aspect ratio in		107	0.1:1..9.99:1 (read only)
H/V zoom pan % (H)		09F	0..100
H/V zoom pan % (V)		0A0	0..100
Image freeze		09C	0..1 = Off, On
H/V crop % (H)		223	0..100
H/V crop % (V)		224	0..100
H/V out shift (H)		0AD	-4096..4096
H/V out shift (V)		0AE	-4096..4096
Shrink level %		087	10..100
Shrink level H %		104	10..100 (only used in Advanced A/R mode)
Shrink level V %		106	10..100 (only used in Advanced A/R mode)
Shrink enable		18E	0..1 = Off, On
H/V shr. pos.% (H)		0DA	0..100
H/V shr. pos.% (V)		0DB	0..100

C2-2375A SERIES OPERATION MANUAL

In (top-left H)		21B	
In (top-left V)		21D	
In (H size)		21C	
In (V size)		21E	
Out (top-left H)		21F	
Out (top-left V)		221	
Out (H size)		220	
Out (V size)		222	
Aspect change		190	0..2 = Normal, Letterbox, Pillarbox
Aspect adjust		102	0..1 = Simple, Advanced
Flicker reduction		092	0..3 = Off, Low, Med, High
Image smoothing		0A1	0..2 = Off, Med, High
Image flip		095	0..3 = Off, Horiz., Vertical, H & V
Temporal interpolation		229	0..1 = Off, On
Show source label		250	0..1 = Off, On
Audio bars		252	0=Off, 1 to 4 audio bars shown.
Max fade level		10F	0..100 = Fade level %
Fade out / in		193	-1 = Fade out 0 = No action 1 = Fade in
Layer priority		144	0..5 = Layer priority
Headphone volume		0FD	-16..15 (-16=Mute)
Audio vol. (volume)		206	-128..127 (for digital audio processing)
Audio vol. (on/off)		207	0..1 = Off, On (for digital audio processing)
Adjust keys (on certain models only)			
Keyer enable		127	0..1 = Off, On
Y key min/max (min)		0AF	0..255
Y key min/max (max)		0B2	0..255
Y key Softness		121	0..255
Y key Invert		122	0..1 = Off, On
U key min/max (min)		0B0	0..255
U key min/max (max)		0B3	0..255
U key Softness		123	0..255
U key Invert		124	0..1 = Off, On
V key min/max (min)		0B1	0..255
V key min/max (max)		0B4	0..255
V key Softness		125	0..255
V key Invert		126	0..1 = Off, On
Swap fore / background		144	0..1 = Off, On
Adjust keyers – edge blending (on certain models only)			
Edge Blend		180	Bit 0 = Left edge active Bit 1 = Right edge active Bit 2 = Top edge active Bit 3 = Bottom edge active
E.blnd guides		18F	0..2 = Off, Auto, On

C2-2375A SERIES OPERATION MANUAL

E.blnd size H		18B	0.. limited by H width
E.blnd size V		18C	0.. limited by V height
E.blnd gamma H		188	1..150 1=0.01, 150=1.50
E.blnd gamma V		18D	1..150 1=0.01, 150=1.50
E.blnd comp cent		198	0..99
E.blnd comp side		19D	0..99
Logos (on certain models only)			
Logo enable		12B	0..1 = Off, On
Logo number		143	0..9 Logo selection
H/V out shift (H)		0AD	0..100 %
H/V out shift (V)		0AE	0..100 %
Max fade level		10F	0..100%
Layer priority		144	0..5
Borders (on certain models only)			
Border enable		150	0..1 = Off, On
Border H size		152	0..99
Border V size		151	0..99
Border H offset		153	0..99
Border V offset		154	0..99
Border Opacity		158	0 (fully transparent) ..100 (solid)
Border Y		155	16..235
Border U		156	16..240
Border V		157	16..240
Adjust sources			
Source to adjust. <i>This only changes what's shown in the menu – use the CHA values below to change settings of a source.</i>	CHA	116	0x10 to 0x1F = RGB1 to RGB16 0x30 to 0x3F = CV1 to CV16 0x40 to 0x4F = YC1 to YC16 0x50 to 0x5F = SDI1 to SDI16 0xD0 = OUT1, 0xD1 = OUT2 0xF0 = TC1, 0xF1 = TC2
Still Image / Testcard	F0..F1	0DC	0..10
Autoset	10..1F	0FE	1= Start Autoset procedure
Aspect correct	10..5F	240	0=Fill (default) 1=Aspect, 2=H-fit, 3=V-fit, 4=1:1
UMD display address	10..5F	263	0 to 126, as per TSL 3.1 protocol
Label font	10..5F	246	0..15 to select different fonts
Label background color	10..5F	247	0=Black 8=Transparent
Label foreground color	10..5F	248	1=Blue 9=Grey
			2=Green 10=Opaque Black
			3=Cyan 11=Opaque White
			4=Red 12=Flashing Blue
			5=Magenta 13=Flashing Green
			6=Yellow 14=Flashing Red
			7=White 15=Flashing White

C2-2375A SERIES OPERATION MANUAL

Label H. Size	10..5F	249	0..8
Label V. Size	10..5F	24A	0..8
Label H. Position	10..5F	24D	0..3 (Off / Left / Center / Right)
Label V. Position	10..5F	24E	0..3 (Off / Top / Middle / Bottom)
Label char. to adj.	10..5F	24B	0..23
Label char. value	10..5F	24C	32..127
EDID to use	10..1F	243	0..7 to specify EDID entries 1..Mon
EDID capture entry#	10..1F	244	0..7 to specify EDID entries 1..Mon
EDID capture Grab	10..1F	245	Set to 1 to Grab. Auto-resets to 0.
HDCP advertise (DVI)	10..1F	237	0=Off, 1=On
HDCP status (DVI)	10..1F	238	0=Inactive, 1=Active
TL pos. adj. (left)	10..FF	0B6	-100..100
TL pos. adj. (top)	10..FF	0B7	-100..100
BR size adj. (right)	10..5F	0DE	-100..100
BR size adj. (bottom)	10..5F	0DF	-100..100
Audio input source (internal)	10..FF	242	0..4 Selects inputs 1 to 4 + Mute.
OPTION audio input	10..FF	0D0	0..9 = Channels 1 .. 10 on A2-2000
Audio vol	10..FF	0CF	-16..15 (-16=Mute)
Bal	10..FF	0D1	-15..15
On source loss (was Deglitch)	10..5F	0A3	0=Show, 1=Freeze, 2=Blue, 3=Black, 4=Remove
Source stable (read only)		22A	0=Unstable, 1=Stable
Input pixel phase	10..5F	091	0..31
RGB input type	10..1F	0C1	8 = Auto 6 = D-RGB 11 = D-YUV 10 = A-RGB 12 = A-YUV For universal HD15 inputs: 5 = CV/YC For units with DVI-U inputs: 13 = CV (or A-CV) 14 = YC (or A-YC) For units with DVI-U 5x BNC breakouts: 15 = B-RGB 16 = B-YUV 17 = B-CV 18 = B-YC
RGB contr. (red)	10..1F	0C5	75..150
RGB contr. (green)	10..1F	0C6	75..150
RGB contr. (blue)	10..1F	0C7	75..150
YUV setup level	10..1F	23E	0=0 IRE, 1=7.5 IRE
De-int.	10..FF	0B8	0..6 = Normal, Auto, Film 3:2, M.comp.low,

C2-2375A SERIES OPERATION MANUAL

			M.comp.med., M.comp.high, Frame/bob
(Film mode detected)	10..FF	0E3	0..1 = Not detected, Detected
Diagonal interpolation	10..FF	22B	0..1 = Off, On
Noise reduction	10..5F	23F	0..1 = Off, On
Bright	30..5F	0BB	0..180
Contrast	30..5F	0BC	0..180
Saturation	30..5F	0B9	0..180
Hue	30..5F	0BA	-180..180
Sharpness	30..5F	080	-7..+7
Luma delay	30..5F	0BD	-4..3
Field swap	10..FF	0C9	0..1 = Off, On (swaps odd/even fields)
Field Offset	10..FF	196	0..7 = -4..+3 (defaults to 4 = 0)
<i>For units with digital audio processing:</i>			
Audio channel 1	10..FF	213	0x00 to 0x07 = SDI1-1 to SD1-8 0x08 to 0x0F = SDI2-1 to SDI2=8 0x10 to 0x1F = AES1 to AES16
Audio channel 2	10..FF	214	
Audio channel 3	10..FF	215	
Audio channel 4	10..FF	216	
Audio channel 5	10..FF	217	
Audio channel 6	10..FF	218	
Audio channel 7	10..FF	219	
Audio channel 8	10..FF	21A	
Adjust audio (on certain models only)			
Source to adj		203	0x00 to 0x07 = SDI1-1 to SD1-8 0x08 to 0x0F = SDI2-1 to SDI2=8 0x10 to 0x1F = AES1 to AES16
Volume trim		205	-128 to 127
Delay adjust		204	-100 to 5000
Adjust transitions (on certain models only)			
Transition type		112	0..3 = Cut, Fade, Wipe, Push
Switching fade time		0F5	0 (off) to 50 (5.0 seconds)
Wipe type		145	0 = Left -> Right 1 = Right -> Left 2 = Up -> Down 3 = Down -> Up 4 = Diagonal 5 = Diamond
Wipe Size		146	10..2000
Audio Control (S2-106AD Only)			
Sample frequency		191	0..4 = Bypass, 32, 44.1, 48, 96kHz
Audio delay		192	0..999 = delay in ms (restricted depending on Sample frequency)
Adjust tally (on certain models only)			
Tally mode		260	0 = Disabled

C2-2375A SERIES OPERATION MANUAL

			1 = Normal 2 = Presets
Tally input number		261	1 to 8
Tally preset to load		262	1 to 50
Adjust resolutions			
Note: You MUST set the 'Image to adjust' value to the correct value first, and only then change the other values - otherwise you may be adjusting the wrong entry. The user should not adjust the 'Image to adjust' entry using the front panel whilst also accessing it via RS232			
Image to adjust		081	1..1000
Output image type		0E2	0 = RGBHV 1 = RGBS 2 = RGsB 3 = YUV 4 = tYUV 7 = tIRGB
Interlaced		0CA	0..1 = Off, On
H.freq.crse		0BE	10000..200000
H.freq.fine		0BF	10000..200000
H/V active (H)		096	64..2047
H/V active (V)		097	64..2047
H/V start (H)		08B	0..1023
H/V start (V)		08C	0..1023
Clks/l		08D	64..4095
Lines/f		08E	64..2047
H/V sync (H)		08F	8..1023
H/V sync (V)		090	1..1023
Sync polarity		094	0..3 = ++, +-, +, --
System			
SW (Software version)		0D2	Read only
PT (Product type)		0C4	Read only
BT (Board type)		0C2	Read only
Advanced menus		11D	0..1, Off, On
Autoset Sense		0FF	0..3 = Low, medium, high, v.high
OSD on Power up		189	0..1, Off, On
RGB1 termination		199	0..2, Off, On, Auto
Store		0C8	Set to 1 to store
Buzzer		0CB	0..1 = Off, On
CC-300 A/B bus enable		202	0..1 = Off, On
Power cycles		0D6	Read only
Firmware updates		0DD	Read only
Hours in use		0D7	Read only
Resolutions		0D8	Read only
Number of Still Images / Testcards		0D9	Read only

C2-2375A SERIES OPERATION MANUAL

Number of logos		14F	Read only																																																				
Board temp. (deg.C)		0CD	Read only																																																				
Air temp. (deg.C)		148	Read only																																																				
Regulators temp.(deg.C)		147	Read only																																																				
PLD temp. (deg.C)		111	Read only																																																				
Fan speed (rpm)		0CE	Read only																																																				
Led brightness		12C	0..100																																																				
LCD backlight		200	0..1 = Off, On																																																				
Serial type (See Specs to see if your unit supports all options)		251	0 = RS-232 1 = RS-422 2 = RS-485																																																				
RS232 Baud rate		0AB	0..6 = 9600, 19200, 28800, 33600, 38400, 57600, 115200																																																				
TAC number 0		15D	Read only																																																				
TAC number 1		15E	Read only																																																				
TAC number 2		15F	Read only																																																				
TAC number 3		160	Read only																																																				
TAC number 4		161	Read only																																																				
TAC number 5		162	Read only																																																				
MAC number (IP port)		208	Read only – bytes reversed!																																																				
Not part of menu system																																																							
Front panel lock		0FC	0 = unlocked, 1 = locked																																																				
Emulate button press		24F	See section below.																																																				
Options installed or attached – read only		264	24-bit number has a bit high to indicate that a unit is attached, or an option installed: <table border="1" style="margin-left: 20px;"> <thead> <tr> <th>Bit</th> <th>Unit</th> <th>Bit</th> <th>Unit</th> </tr> </thead> <tbody> <tr> <td>0</td> <td>Audio switcher</td> <td>12</td> <td>S2-110CV</td> </tr> <tr> <td>1</td> <td>S2-106AD</td> <td>13</td> <td>S2-110YC</td> </tr> <tr> <td>2</td> <td>S2-105PC</td> <td>14</td> <td>S1-101AA</td> </tr> <tr> <td>3</td> <td>S2-105PCA</td> <td>15</td> <td>Ethernet</td> </tr> <tr> <td>4</td> <td>S2-109PC</td> <td>16</td> <td>Tally / UMD module</td> </tr> <tr> <td>5</td> <td>S2-105CV</td> <td>17</td> <td>-</td> </tr> <tr> <td>6</td> <td>S2-105CVA</td> <td>18</td> <td>-</td> </tr> <tr> <td>7</td> <td>S2-105YC</td> <td>19</td> <td>-</td> </tr> <tr> <td>8</td> <td>S2-105YCA</td> <td>20</td> <td>-</td> </tr> <tr> <td>9</td> <td>-</td> <td>21</td> <td>-</td> </tr> <tr> <td>10</td> <td>S2-108HD</td> <td>22</td> <td>-</td> </tr> <tr> <td>11</td> <td>S2-105DVIA</td> <td>23</td> <td>-</td> </tr> </tbody> </table>	Bit	Unit	Bit	Unit	0	Audio switcher	12	S2-110CV	1	S2-106AD	13	S2-110YC	2	S2-105PC	14	S1-101AA	3	S2-105PCA	15	Ethernet	4	S2-109PC	16	Tally / UMD module	5	S2-105CV	17	-	6	S2-105CVA	18	-	7	S2-105YC	19	-	8	S2-105YCA	20	-	9	-	21	-	10	S2-108HD	22	-	11	S2-105DVIA	23	-
Bit	Unit	Bit	Unit																																																				
0	Audio switcher	12	S2-110CV																																																				
1	S2-106AD	13	S2-110YC																																																				
2	S2-105PC	14	S1-101AA																																																				
3	S2-105PCA	15	Ethernet																																																				
4	S2-109PC	16	Tally / UMD module																																																				
5	S2-105CV	17	-																																																				
6	S2-105CVA	18	-																																																				
7	S2-105YC	19	-																																																				
8	S2-105YCA	20	-																																																				
9	-	21	-																																																				
10	S2-108HD	22	-																																																				
11	S2-105DVIA	23	-																																																				

10.4 Examples

Each example shows the packet sent to the unit and its response. When a byte is not required to be sent it is indicated by a '-' in the table below (since a Read is 6 bytes shorter than a Write). Each character shown below is sent as a ASCII character so F0400 is sent as 'F' '0' '4' '0' '0'.

Packet sent

Packet returned

C2-2375A SERIES OPERATION MANUAL

SOP	CMD	CHA	WIN	OUT	FUN	PAY	CS	EOP	SOP	CMD	CHA	WIN	OUT	FUN	PAY	CS	EOP
-----	-----	-----	-----	-----	-----	-----	----	-----	-----	-----	-----	-----	-----	-----	-----	----	-----

Set output 1 window B Source to RGB2

F	04	00	42	00	82	000011	D9	CR	F	44	00	42	00	82	000011	19	CR
---	----	----	----	----	----	--------	----	----	---	----	----	----	----	----	--------	----	----

Set output 1 window A to Enable advanced aspect control

Note checksum is ?? for debugging

F	04	00	41	01	02	000001	??	CR	F	44	00	42	01	02	000001	8A	CR
---	----	----	----	----	----	--------	----	----	---	----	----	----	----	----	--------	----	----

Set 1A Shrink to 110 – invalid max for shrink is 100

F	04	00	41	00	87	00006E	??	CR	F	44	00	41	00	87	000064	70	CR
---	----	----	----	----	----	--------	----	----	---	----	----	----	----	----	--------	----	----

Read 1C Zoom level – invalid as window C does not exist

F	84	00	43	00	86	-	??	CR	F	04	00	43	00	86	000000	CD	CR
---	----	----	----	----	----	---	----	----	---	----	----	----	----	----	--------	----	----

Read 1B Zoom level

F	84	00	42	00	86	-	??	CR
---	----	----	----	----	----	---	----	----

Zoom = 100

F	44	00	42	00	86	000064	70	CR
---	----	----	----	----	----	--------	----	----

Set baud to 9600

F	04	00	42	00	AB	000000	F0	CR
---	----	----	----	----	----	--------	----	----

Reply is at 9600 baud

F	44	00	42	00	AB	000000	30	CR
---	----	----	----	----	----	--------	----	----

Set 1A Zoom = 300

F	04	00	42	00	86	00012C	F7	CR
---	----	----	----	----	----	--------	----	----

F	44	00	42	00	86	00012C	37	CR
---	----	----	----	----	----	--------	----	----

Set 1A Shrink to 50

F	04	00	42	00	87	000032	FE	CR
---	----	----	----	----	----	--------	----	----

F	44	00	42	00	87	000032	3E	CR
---	----	----	----	----	----	--------	----	----

Set 1A Shrink H Posn to 0

F	04	00	42	00	DA	000000	1F	CR
---	----	----	----	----	----	--------	----	----

F	44	00	42	00	DA	000000	5F	CR
---	----	----	----	----	----	--------	----	----

Set 1A Shrink V Posn to 100

F	04	00	42	00	DB	000064	84	CR
---	----	----	----	----	----	--------	----	----

F	44	00	42	00	DB	000064	C4	CR
---	----	----	----	----	----	--------	----	----

10.5 Reading and writing macros

Depending on the unit connected there can be up to 7 macros stored in the unit. These macros can be programmed to perform a specific task, for example enable PIP mode, Position pip window at H=0, V=0, Zoom in to 120%.

The WIN and OUT bytes are not used for macro reading or writing and should be set to WIN=1A and OUT = 0

The CHA byte indicates the macro we are programming / reading / running. Macro 1 to 5 are CHA 0..4, CHA=5 is restore, CHA 6..7 are Macros 6..7.

Macro Restore (CHA=5) is read only, the units restore state is set by sending the Store command (0C8).

C2-2375A SERIES OPERATION MANUAL

Menu text	CHA	FUNC (Hex)	Range of adjustment (decimal)
Macro			
Run macro	0..7	F1	0..1 = Run, Erase macro
Number of items within macro	0..7	F4	Read Only
Function to adjust	0..7	F2	0..4095
Value	0..7	F3	Value for Function

10.5.1 Reading a previously stored Macro

In order to read a macro the following commands must be sent in this specific order – no other commands should be sent between these messages. The CHA in these cases relate not to the source but to the macro we are reading.

Packet sent

Packet returned

SOP	CMD	CHA	WIN	OUT	FUN	PAY	CS	EOP	SOP	CMD	CHA	WIN	OUT	FUN	PAY	CS	EOP
-----	-----	-----	-----	-----	-----	-----	----	-----	-----	-----	-----	-----	-----	-----	-----	----	-----

Read number of items currently stored in Preset 2 read

Returned packet indicates 4 items available to

F	84	01	42	00	F4	-	BB	CR	F	44	01	42	00	F4	00002	FC	CR
---	----	----	----	----	----	---	----	----	---	----	----	----	----	----	-------	----	----

Read the Function for the first item in the preset / macro

Payload is the Function stored – 86 = Zoom

F	84	01	42	00	F3	-	BA	CR	F	44	01	42	00	F3	000086	780	CR
---	----	----	----	----	----	---	----	----	---	----	----	----	----	----	--------	-----	----

Read the Data for the first item in the preset / macro

Payload is the data for the function – 100%

F	84	01	42	00	F2	-	B9	CR	F	44	01	42	00	F2	000064	5D	CR
---	----	----	----	----	----	---	----	----	---	----	----	----	----	----	--------	----	----

Read the Function for the second item in the preset / macro

Payload is the Function stored – 87 = Shrink

F	84	01	42	00	F3	-	BA	CR	F	44	01	42	00	F3	000087	81	CR
---	----	----	----	----	----	---	----	----	---	----	----	----	----	----	--------	----	----

Read the Data for the second item in the preset / macro

Payload is the data for the function – 100%

F	84	01	42	00	F2	-	B9	CR	F	44	01	42	00	F2	000064	5D	CR
---	----	----	----	----	----	---	----	----	---	----	----	----	----	----	--------	----	----

The above example shows the read for all the items within macro 0. The first command reads the number of items available in the macro and resets the read address. Then the following items read the function and then the data for each of the items in the preset/macro. Following a read of the data for a macro internally the next item in the macro is selected for reading so it is not possible to read the same item twice without first re-reading the number of items in the macro.

10.5.2 Writing to a macro

In order to read a preset / macro the following commands must be sent in this specific order – no other commands should be sent between these messages.

Packet sent

Packet returned

SOP	CMD	CHA	WIN	OUT	FUN	PAY	CS	EOP	SOP	CMD	CHA	WIN	OUT	FUN	PAY	CS	EOP
-----	-----	-----	-----	-----	-----	-----	----	-----	-----	-----	-----	-----	-----	-----	-----	----	-----

Clear macro

C2-2375A SERIES OPERATION MANUAL

F	04	02	42	00	F1	000001	3A	CR	F	44	02	42	00	F1	000001	7A	CR
---	----	----	----	----	----	--------	----	----	---	----	----	----	----	----	--------	----	----

Write the function for first item in macro 3 = Zoom

F	04	02	42	00	F3	000086	C1	CR	F	44	02	42	00	F3	000011	01	CR
---	----	----	----	----	----	--------	----	----	---	----	----	----	----	----	--------	----	----

Write data for the first item = 100

F	04	02	42	00	F2	000064	9E	CR	F	44	02	42	00	F2	000011	DE	CR
---	----	----	----	----	----	--------	----	----	---	----	----	----	----	----	--------	----	----

Write the function for the second = shrink

F	04	02	42	00	F3	000087	C2	CR	F	44	02	42	00	F2	000011	02	CR
---	----	----	----	----	----	--------	----	----	---	----	----	----	----	----	--------	----	----

Write the data for the second item = 100

F	04	02	42	00	F2	000064	9E	CR	F	44	02	42	00	F3	000011	DE	CR
---	----	----	----	----	----	--------	----	----	---	----	----	----	----	----	--------	----	----

10.5.3 Run and Restore macros

Macros once programmed can be run by sending one of the following commands. By running macro 5 the unit can be restored to its previously saved state, when used in conjunction with the other macros this allows a default setup or baseline for the unit to be created.

Packet sent

Packet returned

SOP	CMD	CHA	WIN	OUT	FUN	PAY	CS	EOP	SOP	CMD	CHA	WIN	OUT	FUN	PAY	CS	EOP
-----	-----	-----	-----	-----	-----	-----	----	-----	-----	-----	-----	-----	-----	-----	-----	----	-----

Restore

F	04	05	42	00	F1	000000	3C	CR	F	44	05	42	00	F1	000000	7C	CR
---	----	----	----	----	----	--------	----	----	---	----	----	----	----	----	--------	----	----

Run macro 1

F	04	00	42	00	F1	000000	37	CR	F	44	00	42	00	F1	000000	77	CR
---	----	----	----	----	----	--------	----	----	---	----	----	----	----	----	--------	----	----

Run macro 2

F	04	01	42	00	F1	000000	38	CR	F	44	01	42	00	F1	000000	78	CR
---	----	----	----	----	----	--------	----	----	---	----	----	----	----	----	--------	----	----

Run macro 3

F	04	02	42	00	F1	000000	39	CR	F	44	02	42	00	F1	000000	79	CR
---	----	----	----	----	----	--------	----	----	---	----	----	----	----	----	--------	----	----

Run macro 7

F	04	07	42	00	F1	000000	39	3E	F	44	02	42	00	F1	000000	7E	CR
---	----	----	----	----	----	--------	----	----	---	----	----	----	----	----	--------	----	----

10.5.4 Emulate a front panel button press

This is performed using function code 0x24F and the following payload codes (requires firmware version 287 onwards). Note that not all button presses are relevant to your unit.

Button press	Payload
Power down	0400E1
Power back on – see Reset command.	N/A
Reset menu settings to power-on values	0100E2
Reset menu settings to factory defaults	2300E2
Lock / unlock front panel buttons	0100E3
Set to NTSC output	0000E7
Set to PAL output	0000E8
Set to default output resolution for unit	0000E9
Set to 480p output	0000EA

C2-2375A SERIES OPERATION MANUAL

Set to 720p 59.94Hz output	0000EB
Set to 720p 60Hz output	0000EC
Cycle presets (demo mode)	0100EE
Select DVI-I1 as source	000200
Select DVI-I2 as source	000201
Select DVI-I3 as source	000202
Select DVI-I4 as source	0002A2
Select CV1 as source	000203
Select CV2 as source	000204
Select CV3 as source	000205
Select YC1 as source	000206
Select YC2 as source	000207
Select YC3 as source	000208
Select TC1 / SIS1 as source	000209
Select TC2 / SIS2 as source	00020A
Select OUT1 as source	00020B
Select OUT2 as source	00020C
Toggle window A/B/Z	00020D
Toggle output 1/2	00020E
TAKE (activate transition)	00020F
FREEZE	000211
KEY	000212
MIX	00024D
INPUT	00024E
AUTOSET	00024F
FADE	000251
ZOOM	000252
PAN	000253
SIZE	000254
POS	000255
LOCK	000256
PIP	000257
MIX / PIP	00025A
ASPECT	00025D
PAN / POS	00026F
ZOOM	000270
LOCK / MIX	000269
Decrease Shrink value	000213
Increase Shrink value	000214
Decrease Zoom value	000215
Increase Zoom value	000216
Reset settings to power-on values	000217
Identify current window	000218
Run Macro 1	000219
Run Macro 2	00021A
Run Macro 3	00021B
Run Macro 4	00021C

C2-2375A SERIES OPERATION MANUAL

Run Macro 5	00021D
Run Macro 6	000267
Run Macro 7	000268
Add to Macro 1	020119
Add to Macro 2	02011A
Add to Macro 3	02011B
Add to Macro 4	02011C
Add to Macro 5	02011D
Add to Macro 6	020167
Add to Macro 7	020168
Erase Macro 1	280119
Erase Macro 2	28011A
Erase Macro 3	28011B
Erase Macro 4	28011C
Erase Macro 5	28011D
Erase Macro 6	280167
Erase Macro 7	280168
Decrease Horizontal Pan value	00021E
Increase Horizontal Pan value	00021F
Decrease Vertical Pan value	000220
Increase Vertical Pan value	000221
Select window A	000223
Select window B	000224
Select window C	0002A0
Select window D	0002A1
Select window Z	000225
Select Output 1	000226
Select Output 2	000227
SELECT (menu adjust)	000128
Left rotary (menu adjust rotary control)	000129
Right rotary (menu adjust rotary control)	00012A
Left (menu adjust)	000158
Right (menu adjust)	000159
Decrement / ZOOM (menu adjust)	00024B
Increment / FREEZE (menu adjust)	00024C
Decrement / PIP (menu adjust)	00029E
Increment / KEY (menu adjust)	00029F
Set transition to FADE	00026A
Set transition to WIPE	00026B
Set transition to PUSH	00026C
Select SD1 as source	00022B
Select SD2 as source	00022C
Select SD3 as source	0002A4
Select SD4 as source	0002A5
Select DVI1 as source for window A	00023C
Select DVI2 as source for window A	00023D
Select DVI3 as source for window A	00023E

C2-2375A SERIES OPERATION MANUAL

Select CV1 as source for window A	00023F
Select CV2 as source for window A	000240
Select CV3 as source for window A	000241
Select YC1 as source for window A	000242
Select YC2 as source for window A	000243
Select YC3 as source for window A	000244
Select TC1 as source for window A	000245
Select TC2 as source for window A	000246
Select OUT1 as source for window A	000247
Select OUT2 as source for window A	000248
Select SDI1 as source for window A	000249
Select SDI2 as source for window A	00024A
Select SDI3 as source for window A	000271
Select SDI4 as source for window A	000272
Select SDI5 as source for window A	000273
Select SDI6 as source for window A	000274
Select SDI7 as source for window A	000275
Select SDI8 as source for window A	000276
Select DVI1 as source for window B	00022D
Select DVI2 as source for window B	00022E
Select DVI3 as source for window B	00022F
Select CV1 as source for window B	000230
Select CV2 as source for window B	000231
Select CV3 as source for window B	000232
Select YC1 as source for window B	000233
Select YC2 as source for window B	000234
Select YC3 as source for window B	000235
Select TC1 as source for window B	000236
Select TC2 as source for window B	000237
Select OUT1 as source for window B	000238
Select OUT2 as source for window B	000239
Select SDI1 as source for window B	00023A
Select SDI2 as source for window B	00023B
Select SDI3 as source for window B	000277
Select SDI4 as source for window B	000278
Select SDI5 as source for window B	000279
Select SDI6 as source for window B	00027A
Select SDI7 as source for window B	00027B
Select SDI8 as source for window B	00027C
Lock to CV1	00025B
Lock to YC1	00025C
Toggle CV1 / YC1 as source	00025E
Toggle CV2 / YC2 as source	00025F
Toggle DVI-D1 / SDI1 as source	000260
Toggle RGB1 / YUV1 as source	000261
Select DVI-D1 as source	000262
Select RGB1 as source	000263

C2-2375A SERIES OPERATION MANUAL

Select RGB2 as source	00027D
Select YUV1 as source	000264
Logo 1A toggle on/off	000265
Logo 2B toggle on/off	000266
Window 1A toggle on/off	00026D
Window 2B toggle on/off	00026E
Go to Lock menu item	00027E
Output 1 toggle on/off	00027F
Output 2 toggle on/off	000280
Select UNI1 as source for window A	000281
Select UNI2 as source for window A	000282
Select UNI3 as source for window A	000283
Select UNI4 as source for window A	000284
Select UNI5 as source for window A	000285
Select UNI6 as source for window A	000286
Select UNI7 as source for window A	000287
Select UNI8 as source for window A	000288
Select UNI1 as source for window B	000289
Select UNI2 as source for window B	00028A
Select UNI3 as source for window B	00028B
Select UNI4 as source for window B	00028C
Select UNI5 as source for window B	00028D
Select UNI6 as source for window B	00028E
Select UNI7 as source for window B	00028F
Select UNI8 as source for window B	000290
Load Preset 1	000291
Load Preset 2	000292
Load Preset 3	000293
Load Preset 4	000294
Load Preset 5	000295
Load Preset 6	000296
Load Preset 7	000297
Load Preset 8	000298
Load Preset 9	000299
Load Preset 10	00029A
Store Preset 1	020191
Store Preset 2	020192
Store Preset 3	020193
Store Preset 4	020194
Store Preset 5	020195
Store Preset 6	020196
Store Preset 7	020197
Store Preset 8	020198
Store Preset 9	020199
Store Preset 10	02019A
Erase Preset 1	280191
Erase Preset 2	280192

C2-2375A SERIES OPERATION MANUAL

Erase Preset 3	280193
Erase Preset 4	280194
Erase Preset 5	280195
Erase Preset 6	280196
Erase Preset 7	280197
Erase Preset 8	280198
Erase Preset 9	280199
Erase Preset 10	28019A
Set output to BLACK	00029B
Set output to WHITE	00029C
Toggle edge blend lines on/off	00029D
Cycle scaler inputs	0002A3

I.e. insert the 6 digit code from above into the following text string:
F041041024F#####??<CR>

E.g. to Load Preset 1, use the text string:
F041041024F000291??<CR>

10.5.5 Reset command

This is a special command to reset a unit (as if power had been removed and re-applied). Note that unlike the above commands, this is sent as binary (i.e. not as ASCII text).

0x53, 0x06, 0x04, 0x01, 0x55, 0xAA, 0x55, 0xB2

E.g. In Visual Basic, send the string:
Chr(&H53) + Chr(&H6) + Chr(&H4) + Chr(&H1) + Chr(&H55) + Chr(&HAA)
+ Chr(&H55) + Chr(&HB2)

COMMON OPERATIONS

This section provides step by step instructions for some common operations.

10.6 Operation of the Keyer

Some units come equipped with a very powerful Luminance and Chrominance Keyer. The Keyer can take some time to master and below is a breakdown and series of simple steps to help you master the Keyer's operation

When adjusting the values, please bear in the mind the following:

The Y value is the Luminance value, so 0 is black and 255 is very bright (white).

The U value is the B-Y component. This is the difference between the Blue and the Luminance value. If part of an image is black, grey or white, then its value is 128 (being the mid-point).

The V value is the R-Y component. This is the difference between the Red and the Luminance value. If part of an image is black, grey or white, then its value is 128 (being the mid-point).

10.6.1 Preparation:

1. Enter the Adjust windows menu.
2. Select the Source (this will be the foreground).
3. Exit the Adjust windows menu.
4. Enter the Adjust keyers menu.
5. Ensure the Keyer is Off.
6. Set all Y, U and V min/max values to [0] [255].
7. Set all Y, U and V softness values to 0.
8. Set all Y, U and V invert values to Off.
9. Turn the Keyer On.

At this point your source image will have disappeared, since all colors have been keyed out.

10.6.2 Adjustment:

Knowing which color(s) you want to key out from the image, e.g. black to disappear, perform the following set of steps:

1. Increase the Y Key Min from 0 until just before the required color (Key Color) appears.
2. Decrease the Y Key Max from 255 until just before the required color (Key Color) appears.
3. Repeat steps 1 & 2 for the U and V min/max values as well.

Adjust any of the Softness values to improve the key. If your input signal is slightly noisy or if you want to soften the edges within the image, then this may require you

C2-2375A SERIES OPERATION MANUAL

to decrease the 'min' values and increase the 'max' values to broaden the range of colors keyed out.

At this point, only the key color should remain transparent.

11 TROUBLESHOOTING AND TECHNICAL SUPPORT

If problems are experienced, please read through the symptom topics below in order to resolve the problem. After doing so, if you still need to, contact Technical Support at <http://www.tvone.com/support>. Please have the following details of the problem handy:

Whether the problem happens only at specific times or has only just started occurring (and what other things have changed at the same time).

Firmware revision numbers - found in the first item of the System menu:

If the problem relates to a specific source or resolution:

11.1 There is no picture on the Output.

If no LEDs are on, then ensure that the AC power adaptor is connected properly and the power switch is on at the AC outlet.

If the Standby/ON LED on the unit is off but another blue LED is active then check that the monitor output from the computer is connected at both the computer and the unit. Check that the output connector you are using from the unit is also connected at the unit and the display equipment.

Check that the display video equipment is set to the correct line input and format/standard as appropriate.

Check that the device connected to the output is on and can support the resolution set in the Adjust output menu, ensuring that the Sync type e.g. RGBHV, is also set correctly.

11.2 The image is shifted and not fully viewable

There are several ways to correct this, depending on the actual problem, although it's generally best to perform a Factory reset.

Try an AUTOSET if the input is RGB or YUV/YCbCr. Next adjust the TL pos. adj. values in the Setup Program source menu until the incoming video signal is displayed correctly. You may also need to adjust the BR size adj. setting to ensure the incoming video signal is properly displayed.

11.3 The output resolutions no longer appear as expected.

Because any changes made in the Adjust resolutions menu are automatically stored, it may be that the resolution data has become altered or corrupted beyond the ability of a display to show it.

Either manually correct the resolution data, or restore the data to full factory conditions by doing a firmware update. The user should avoid altering the resolution parameter data unless absolutely necessary.

11.4 There is excessive flicker on the Output.

Try using a different Flicker reduction mode. Turning the contrast down and the brightness up on the output device can have a large effect on flicker. Or try adjusting the brightness and contrast of the source input by selecting the Input adjust menu.

11.5 The Output image is distorted.

This may occur where some of the areas of the image are very dark and others are very bright. The solution is to adjust the contrast and brightness settings on your Output device to rectify the problem.

Alternatively, if the Adjust resolutions menu has been used to the output resolution in question, a firmware update is recommended to perform a FULL factory reset.

11.6 Some colors appear to be incorrect on the CV/YC output

First try altering the color, contrast and brightness settings on your TV or video display. These are usually set up for a very different reason than viewing computer graphics and may need changing to suit. If you cannot achieve exactly what you desire then alter the inputs levels in Adjust sources until the correct colors are restored.

11.7 How can I reduce color smearing on CV connections?

Smearing usually occurs on Composite Video connections and is generally unavoidable - unless you can switch to using S-Video or RGB / YUV connections. It occurs because the brightness and color information is transmitted as one combined (composite) signal and the two parts have to be 'bandwidth-limited' to avoid them interfering with each other – which then reduces the quality.

11.8 I can no longer adjust the Output image resolution.

When the unit is in Lock mode, the output resolution is fixed to be the same as the Lock source input resolution. During this time the Output image menu item is not displayed.

11.9 The picture on the video display is black and white.

Ensure that all the cables are correctly connected. If you are using a PAL TV to display the output then the unit may be providing resolution set to NTSC mode, or vice versa.

11.10 The picture on the video display is green.

The Output type is probably incorrectly set to YUV mode, whereas you are connecting to an RGB monitor – see Adjust outputs menu.

11.11 The RGB input is selected but the image is rolling or pink.

Check the Adjust sources menu and confirm that the input type and sync method is set correctly. (Having YUV input selected, instead of RGBHV often causes this problem).

11.12 The video signal from my DVD player does not appear to work.

Some DVD players have a switch at the back that selects between 'Component' and 'S-Video' output, because most will not let you output both at the same time. Make sure it is in the right position for the output you want.

11.13 Image is flashing, snow is present, or source image does not appear.

You may be experiencing a HDCP compatibility problem.

If one of the sources you are using is HDCP encrypted, and your unit is not set to output HDCP, then your unit will not allow the source image to pass through the unit (it may flash on and off).

The solution (if your unit supports HDCP) is to ensure it is enabled in both 'Adjust outputs' and in the 'Adjust sources' menu for that source signal.

If your unit does not support HDCP, or your output device does not support HDCP (e.g. an analog monitor), then there is no way to display a HDCP encrypted source signal.

12 RETURN PROCEDURE

Before returning your unit for repair, there are several checks you can make yourself to make sure the problem is actually caused by a failure.

12.1 Are you sure there's a fault?

Many 'faults' are due to incorrect set-up or use so a simple checklist is provided below to help you identify potential problems.

Set the unit up with your equipment as described in this manual and run through the checklist. This will hopefully determine whether or not the unit is actually faulty and prevent units from being returned unnecessarily.

Check the Troubleshooting tips of this manual and check out the various FAQ (Frequently Asked Questions) listings on the support website, <http://www.tvone.com/support>, which shows the latest Hints, Tips and Solutions.

Don't presume it is the unit that is causing the problem. Check that the equipment being used with it is fully working and setup correctly – bypass the unit if possible by connecting the video source directly to the video display.

Check the AC power. Is it present and is the unit turned on? Check that all cables are properly plugged in and are not damaged and then make certain that all equipment connected to the unit is working properly.

Perhaps you have a "frozen" unit and you cannot change an input nor exit from the current task. In that case, a simple 'Factory Reset' of the product may sort the problem out. See earlier section on Front panel buttons to do this. Note that all user-settings will be lost following an engineering reset.

It is also worth ensuring that the latest firmware is installed in the unit – although, again, user settings are lost during a firmware update.

12.2 To return a unit for repair

First contact TV One using the <http://www.tvone.com/support> website. Support personnel will determine whether a return to the factory is the appropriate solution. If that's the case, a Return Authorization Number will be issued. You should provide the following information for each unit:

Product type

Serial number of the faulty unit (this is on the underside of the unit)

Full details of fault

Invoice number (if available)

Units should be returned via insured carrier or registered mail (thus allowing a trace to be made if the Processor is lost in transit), with shipping costs and insurance arranged at your own risk and expense. Goods in transit are the responsibility of the sender and the supplier will not be responsible for transit losses.

C2-2375A SERIES OPERATION MANUAL

Please clearly state the return number on the outside packaging and on any accompanying documentation. This will greatly speed up processing.

IMPORTANT: DO NOT return a unit for warranty repair without first obtaining a Return Authorization Number. No action will be taken on a unit returned in warranty for repair without a Return Authorization Number

13 WARRANTY POLICY

LIMITED WARRANTY – With the exceptions noted in the next paragraph, TV One warrants the original purchaser that the equipment it manufactures or sells will be free from defects in materials and workmanship for a period of five years from the date of purchase. Should this product, in TV One's opinion, prove defective within this warranty period, TV One, at its option, will repair or replace this product without charge. Any defective parts replaced become the property of TV One. This warranty does not apply to those products which have been damaged due to accident, unauthorized alterations, improper repair, modifications, inadequate maintenance and care, or use in any manner for which the product was not originally intended.

Items integrated into TV One products that are made by other manufacturers, notably computer hard drives and liquid crystal display panels, are limited to the term of the warranty offered by the respective manufacturers. Such specific warranties are available upon request to TV One.

If repairs are necessary under this warranty policy, the original purchaser must obtain a Return Authorization Number from TV One and return the product to a location designated by TV One, freight prepaid. After repairs are complete, the product will be returned, freight prepaid.

LIMITATIONS - All products sold are "as is" and the above Limited Warranty is in lieu of all other warranties for this product, expressed or implied, and is strictly limited to five years from the date of purchase. TV One assumes no liability to distributors, resellers or end-users or any third parties for any loss of use, revenue or profit.

TV One makes no other representation of warranty as to fitness for the purpose or merchantability or otherwise in respect of any of the products sold. The liability of TV One with respect to any defective products will be limited to the repair or replacement of such products. In no event shall TV One be responsible or liable for any damage arising from the use of such defective products whether such damages be direct, indirect, consequential or otherwise, and whether such damages are incurred by the reseller, end-user or any third party.

14 CONNECTOR PINOUTS

14.1 DVI-U connector

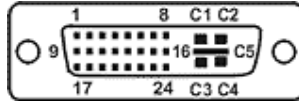

PIN#	SIGNAL	PIN#	SIGNAL				
1	T.M.D.S DATA 2-	16	HOT PLUG DETECT				
2	T.M.D.S DATA 2+	17	T.M.D.S DATA 0-				
3	T.M.D.S 2/4 SHIELD	18	T.M.D.S DATA 0+				
4	Not used	19	T.M.D.S DATA 0/5 SHIELD				
5	Not used	20	Not used				
6	DDC CLOCK	21	Not used				
7	DDC DATA	22	T.M.D.S CLOCK SHIELD				
8	ANALOG VERT. SYNC	23	T.M.D.S CLOCK+				
9	T.M.D.S DATA 1-	24	T.M.D.S CLOCK-				
10	T.M.D.S DATA 1+						
11	T.M.D.S 1/3 SHIELD	C1	ANALOG	R	C	*	Pr
12	Not used	C2	ANALOG	G	*	CV	Y
13	Not used	C3	ANALOG	B	Y	*	PB
14	+5V POWER	C4	ANALOG HORZ SYNC				
15	GND	C5	ANALOG GROUND				

14.2 RS232/422/485 D9 socket

Pin	RS-232	RS-422 Full duplex	RS-485 Half-duplex
1	-	TX- (from unit)	A (link to pin 9)
2	TX (from unit)		
3	RX (to unit)		
4	-	RX+ (to unit)	B (link to pin 6)
5	GND	GND	GND
6	-	TX+ (from unit)	B (link to pin 4)
7	CTS (to unit)		
8	RTS (from unit)		
9	-	RX- (to unit)	A (link to pin 1)

'To unit' means signals are coming from a controller and being received by the unit.
 'From unit' means signals are coming from the unit and being sent to a controller.
 RS-422 may require termination across the RX+/- pins (usually 120 Ohm).
 RS-485 needs pins linked as shown and may require termination across the A/B pins (usually 120 Ohm).

C2-2375A SERIES OPERATION MANUAL

You can select the serial standard in the 'System' menu.

15 SPECIFICATIONS

15.1 Video Inputs

Connection: (CV, YC on DVI-U or BNC break-outs)

Input impedance: 75 Ohm

Television standards supported: NTSC and PAL

CV/YC video decoder: 8-bit Digital

De-Interlacing (NTSC / PAL up-conversion only): pixel-level motion adaptive with noise reduction

Comb filter decoding: adaptive

Film mode (NTSC) 3:2 pull down for up-conversion

CV/YC Video adjustments: contrast, brightness, saturation, hue (NTSC)

15.2 Reference Input

Connection: CV or Tri-level HD (720p, 1080i, 1080p) on BNC

CV/YC sub-carrier lock range: +/- 200Hz for NTSC Operation, +/- 250Hz for PAL Operation

15.3 Computer Digital Inputs

Connection: DVI-D (on DVI-I connector) supporting up to 162MHz (1920x1200 @ 60Hz).

Supports HDCP repeater functionality.

EDID 1.3 data on DVI-D connector to communicate available resolutions.

Compatible with HDMI inputs (change EDID setting in Adjust sources).

Supports audio input when HDMI input active.

15.4 Analog inputs

Connection: RGBHV / YPbPr on DVI-I connector, or BNC break-out

Analog RGB/YPbPr supporting RGBHV, RGBS, RGsB, YPbPr, auto-terminating into 75 Ohm

Digital sync (in RGBHV or RGBS mode): TTL Level, 10K termination, pos or negative

Analog sync (in RGsB, YPbPr, YUV modes): 0.3v negative.

Analog RGB Level Range: 0.5-2.0 Vp-p approx.

De-Interlacing (YUV/YPbPr only): pixel-level motion adaptive with noise reduction

Scan Rate Detection: automatic

Analog PC Resolutions: any up to 2048x2048

Analog HDTV Resolutions: any up to 1080p

Analog max horizontal scan rate: 150kHz

15.5 Video Outputs

Connection: (CV, YC on DVI-I or BNC break-outs)

Output impedance 75 Ohm

Television standards supported: NTSC and PAL

Composite Video 1v p-p
S-Video (YC) 1v p-p

15.6 Computer Digital Outputs

Connection: DVI-D on DVI-I connector, supporting up to 162MHz maximum clock/pixel rate (1920x1200 @ 60Hz).
C2-2000A series units with DVI input and output support HDCP.
Supports HDCP repeater functionality.
Can output HDMI-compatible signal with audio.

15.7 Analog Outputs

Connection: RGBHV / YPbPr on DVI-I connector, or BNC break-out
Analog output impedance 75 Ohm
Analog RGBHV, RGSB, YPbPr (0.7v RGB / 1.0v sync-tip to white)
Analog PC Resolutions: any up to 2048x2048 (user adjustable)
Analog HDTV Resolutions: any up to 1080p
Vertical Refresh Rate: any to 250Hz

15.8 SDI inputs & outputs

Compliant with SDI, HD-SDI and 3G-SDI.
SDI-SDI: SMPTE 259M-C (Jitter <0.10UI)
HD-SDI: SMPTE 292M (Jitter <0.20UI)
3G-SDI: SMPTE 425M-A (Jitter <0.30UI)

15.9 Locking/Mixing

Keyer: chromakey (YUV) or lumakey (Y)
Mixer: PC / Video, foreground/background swappable
PIP: variable window size & position – single-button enabling

15.10 Scaling / sampling / memory

Size and position: automatic via AutoSet or Manual
Image size: user-definable presets
Image freeze: one video frame
Settings memory: non-Volatile
Zoom range: variable to 10x Zoom (1000%)
Shrink range: variable to 10%
Image mirroring: Horizontal and/or Vertical
Horizontal filtering: full digital
De-interlacing: Motion pixel adaptive with noise reduction
Frame-rate conversion: Temporal on Output 1, Frame add/drop on Output 2
Conversion technology: proprietary
Color resolution: 24-bit (16.8 Million Colors)
Max sampling rate: 162MHz maximum
Digital sampling: RGB 24-bit 4:4:4 format, YUV 20-bit 4:2:2 format
Firmware memory: flash, upgradeable via RS-232

15.11 Reliability

MTBF has been calculated to be 35,000+ hours

15.12 Warranty

See warranty policy for further details.

15.13 Regulatory Compliance

Main unit conforms to FCC, CE, RoHS

15.14 Environmental

Operating Temperature 0° to +50° C (+32° to +122° F)

Operating Humidity 10% to 85%, Non-condensing

Storage Temperature -10° to +70° C (+14° to +158° F)

Storage Humidity 10% to 85%, Non-condensing

15.15 Power Requirement

Power inlet: Auto-sensing 110v / 230v AC.

(Optional factory-fitted redundant PSU, with optional factory-fitted 2nd power inlet.)

15.16 Control Methods

The unit can be controlled locally via the front panel buttons, multi-directional switch and Liquid Crystal Display. It can also be controlled remotely via the RS-232 interface using a D9 female connector or again remotely using Ethernet via a RJ45 Ethernet connector.

15.17 Accessories Included

Varies depending on unit.

15.18 Mechanical

Enclosure size (H x W x D): 1.73" x 17.0" x 13.1" (44 x 431 x 334mm)

Weight (Net): 10.6 lbs (4.82 kg)

15.19 Optional Accessories

TBA

16 CONTACT INFORMATION

Should you have any questions or require assistance with this product in areas not covered by this manual, please contact TV One at the appropriate location shown below:

TV One USA

2791 Circleport Drive
Erlanger, KY 41018
USA
Tel 859-282-7303
Fax 859-282-8225
sales@tvone.com
www.tvone.com

TV One Asia

16F-4, No. 75, Sec. 1
Hsin Tai Wu Rd.,
Hsichih,
Taipei Hsien 22101
Taiwan ROC
Tel +886 2 2698 2296
Fax +886 2 2698 2297
sales.asia@tvone.com
www.tvoneasia.com

TV One Latin America

6991 NW 82 Ave # 8
Miami, FL 33166
USA
Tel 305-396-6275
Fax 305-418-9306
sales.latinoamerica@tvone.com
www.tvonela.com

TV One Europe

Continental Approach
Westwood Industrial Estate
Margate, Kent CT9 4JG, UK
Tel +44 (0)1843 873311
Fax +44 (0)1843 873312
sales.europe@tvone.com
www.tvone.eu

TV One China

Room 1007, Golden Peach Building
No.1900 Shangcheng Road

Pudong, Shanghai,
China 200120
Tel +86 21 5830-2960
Fax +86 21 5851-7949
sales.china@tvone.com
www.tvonechina.com

TV One Mercosur

Honduras 5849 2nd Floor Office C
(C1414BNI) Capital Federal
Buenos Aires, Argentina
Tel +54 11 4771-5570
Fax +54 11 4771-5570
sales.latinoamerica@tvone.com
www.tvonela.com